

Prepared by:  
Proctor Engineering Group, Ltd.  
San Rafael, CA 94901  
(415) 451-2480

# **Comprehensive Diagnostic and Improvement Tools for HVAC-System Installations in Light Commercial Buildings**

Prepared for:  
United States Department of Energy  
National Energy Technology Laboratory  
DOE Award No. DE-FC26-01NT41256

**Final Report**  
October 31, 2004

Contributors:  
Abram Conant  
Mark Moder  
Joe Pira  
John Proctor, P.E.  
Mike Gebbie

Creators of CheckMe!®



## ***DISCLAIMER***

This report was prepared as an account of work sponsored by an agency of the United States Government. Neither the United States Government nor any agency thereof, nor any of their employees, makes any warranty, express or implied, or assumes any legal liability or responsibility for the accuracy, completeness, or usefulness of any information, apparatus, product, or process disclosed, or represents that its use would not infringe privately owned rights. Reference herein to any specific commercial product, process, or service by trade name, trademark, manufacturer, or otherwise does not necessarily constitute or imply its endorsement, recommendation, or favoring by the United States Government or any agency thereof. The views and opinions of authors expressed herein do not necessarily state or reflect those of the United States Government or any agency thereof.

## **ABSTRACT**

---

Proctor Engineering Group, Ltd. (PEG) and Carrier-Aeroseal LLP performed an investigation of opportunities for improving air conditioning and heating system performance in existing light commercial buildings. Comprehensive diagnostic and improvement tools were created to address equipment performance parameters (including airflow, refrigerant charge, and economizer operation), duct-system performance (including duct leakage, zonal flows and thermal-energy delivery), and combustion appliance safety within these buildings. This investigation, sponsored by the National Energy Technology Laboratory, a division of the U.S. Department of Energy, involved collaboration between PEG and Aeroseal in order to refine three technologies previously developed for the residential market: 1) an aerosol-based duct sealing technology that allows the ducts to be sealed remotely (i.e., without removing the ceiling tiles), 2) a computer-driven diagnostic and improvement-tracking tool for residential duct installations, and 3) an integrated diagnosis verification and customer satisfaction system utilizing a combined computer/human expert system for HVAC performance. Prior to this work the aerosol-sealing technology was virtually untested in the light commercial sector—mostly because the savings potential and practicality of this or any other type of duct sealing had not been documented. Based upon the field experiences of PEG and Aeroseal, the overall product was tailored to suit the skill sets of typical HVAC-contractor personnel.

## TABLE OF CONTENTS

<b>ABSTRACT .....</b>	<b>i</b>
<b>EXECUTIVE SUMMARY .....</b>	<b>vi</b>
<b>I. INTRODUCTION.....</b>	<b>1-1</b>
1.1 BACKGROUND.....	1-1
<i>Duct Leakage in Light Commercial Buildings.....</i>	<i>1-1</i>
<i>Duct Location in Light Commercial Buildings.....</i>	<i>1-2</i>
<i>HVAC Unit Performance in Light Commercial Buildings.....</i>	<i>1-3</i>
<i>Economizers in Light Commercial Buildings.....</i>	<i>1-4</i>
<b>II. COMPREHENSIVE PROTOCOL.....</b>	<b>2-1</b>
2.1 AEROSEAL .....	2-1
2.2 AEROSEAL LIGHT-COMMERCIAL DIAGNOSTIC PROTOCOL.....	2-2
<i>Leakage Diagnostic Analysis.....</i>	<i>2-2</i>
<i>Fan Pressurization Methodology.....</i>	<i>2-3</i>
2.3 AEROSEAL LIGHT-COMMERCIAL SEALING PROTOCOL .....	2-4
2.4 CHECKME!.....	2-8
<i>The CheckMe! Components.....</i>	<i>2-8</i>
2.5 CHECKME! PROCEDURES .....	2-10
2.6 CHECKME! POST PRODUCTION.....	2-11
2.7 HVAC LOOKUP SOFTWARE .....	2-11
2.8 ECONOMIZER DIAGNOSTIC PROTOCOL.....	2-11
<i>Economizer and control system identification.....</i>	<i>2-12</i>
<i>Verification of functionality and operating characteristics.....</i>	<i>2-13</i>
<i>Control system tuning.....</i>	<i>2-17</i>
2.9 COMBUSTION SAFETY PROTOCOL.....	2-18
<i>Procedures and Work Flow.....</i>	<i>2-19</i>
<i>Performance Standards.....</i>	<i>2-19</i>
<i>Prescriptive Measures.....</i>	<i>2-20</i>
2.10 CHECKME!-AEROSEAL INTEGRATION .....	2-20
<i>Common contractor recruiting.....</i>	<i>2-20</i>
<i>Unique data identifiers.....</i>	<i>2-21</i>
<i>Monthly synchronization.....</i>	<i>2-21</i>
<i>Mutual marketing to home/building owners.....</i>	<i>2-22</i>
<b>III. SITE MONITORING AND RESULTS .....</b>	<b>3-1</b>
3.1 SITE SELECTION AND DIAGNOSTICS .....	3-1
3.2 MONITORING EQUIPMENT AND PROCEDURES .....	3-3
<i>Monitoring Equipment and Procedures.....</i>	<i>3-3</i>
3.3 SITE DESCRIPTION AND REPAIRS .....	3-5
<i>Site #1:.....</i>	<i>3-6</i>
<i>Site #2:.....</i>	<i>3-6</i>
<i>Site #3:.....</i>	<i>3-6</i>
<i>Site #4:.....</i>	<i>3-6</i>
<i>Site #5:.....</i>	<i>3-7</i>
<i>Site #6:.....</i>	<i>3-8</i>
<i>Duct Sealing Data.....</i>	<i>3-8</i>
<i>Economizer Function.....</i>	<i>3-9</i>
<i>Economizer Protocol Field Test.....</i>	<i>3-9</i>
3.4 ANALYSIS METHODOLOGY .....	3-9
<i>Sensible Steady State Efficiency (including return duct effects).....</i>	<i>3-9</i>
<i>Return Duct Heat Gain.....</i>	<i>3-10</i>
3.5 SAVINGS ANALYSIS.....	3-11

*Sensible Steady State Efficiency (including return duct effects)*..... 3-11  
*Return Duct Heat Gain*..... 3-13

**IV. CONCLUSION**..... **4-1**

**REFERENCES** ..... **REF-1**

**APPENDIX A: COMBUSTION SAFETY PROCEDURE FORMS**..... **A-1**

**APPENDIX B: AEROSEAL PROTOCOLS FOR LIGHT-COMMERCIAL DUCT LEAKAGE DIAGNOSIS AND SEALING** .....**B-1**

**APPENDIX C: ECONOMIZER DIAGNOSTICS FORM** ..... **C-1**

**APPENDIX D: AIR CONDITIONER TESTING FORM** ..... **D-1**

**APPENDIX E: HVAC LOOKUP INSTALLATION MANUAL** ..... **D-1**

INSTALLATION..... D-2  
*System Requirements* ..... D-2  
*Do you need the Microsoft Access 2000 Runtime?*..... D-2

RUNNING THE INSTALLER..... D-3  
*Microsoft Access 2000 Runtime*..... D-5

**APPENDIX F: HVAC LOOKUP USER GUIDE** .....**E-1**

DESCRIPTION .....E-2  
DATA SOURCES - WHAT'S IN THE DATABASE? .....E-2  
GETTING STARTED .....E-3  
HOW TO SEARCH .....E-4  
*Filters* .....E-5  
*Pattern Matching and Ranking*.....E-6  
*Combining Filters with Pattern Matching and Ranking*.....E-7  
*Sorting* .....E-8  
*Wildcards*.....E-8

## LIST OF TABLES

TABLE 1.1.1 SMALL COMMERCIAL HVAC PROBLEMS.....	1-3
TABLE 2.8.1 TITLE 24 ECONOMIZER CONTROL REQUIREMENTS .....	2-18
TABLE 3.1.1 DIAGNOSTIC RESULTS.....	3-2
TABLE 3.2.1 SENSOR DESCRIPTION .....	3-3
TABLE 3.2.2 MONITORING EQUIPMENT .....	3-4
TABLE 3.2.3 MONITORING EQUIPMENT ACCURACY .....	3-4
TABLE 3.3.1 MONITORED SITE CHARACTERISTICS .....	3-5
TABLE 3.5.1. SENSIBLE EER REGRESSIONS .....	3-11
TABLE 3.5.2: RETURN DUCT TEMPERATURE GAIN REGRESSIONS.....	3-13

## LIST OF FIGURES

FIGURE 1.1.1: DRUGSTORE CEILING TILES LIFTED TO EXPOSE CEILING-TOP INSULATION .....	1-2
FIGURE 1.1.2: DRUGSTORE DUCTWORK INSTALLED ABOVE INSULATED CEILING TILES .....	1-2
FIGURE 1.1.3: LIQUOR STORE CEILING TILES LIFTED TO EXPOSE CEILING-TOP INSULATION .....	1-2
FIGURE 1.1.4: UNINSULATED ROOF-DECK .....	1-3
FIGURE 2.1.1: AROSEAL SEALING MACHINE, COMPUTER-CONTROL SUITCASE, AND DIAGNOSTIC TOOLS (FLOW CAPTURE HOOD, AND INFRARED LASER-GUIDED TEMPERATURE- MEASUREMENT GUN).....	2-2
FIGURE 2.2.1: PLASTIC FILM TAPE ABOVE AND BELOW A MAGNETIC SHEET - DIFFUSER PREPARED FOR SEALING.....	2-3
FIGURE 2.2.2: FOAM PLUG IN THE CENTRAL DISCHARGE OF A HINGED DIFFUSER.....	2-3
FIGURE 2.2.3: EQUAL LENGTH TUBING AVERAGES SUPPLY AND RETURN-SIDE DUCT PRESSURES DURING TESTING AND SEALING.....	2-4
FIGURE 2.3.1: WYE SPLITS AEROSOL FLOW BETWEEN SUPPLY AND RETURN.....	2-5
FIGURE 2.3.2: HIGH-FLOW SCRUBBER-FAN SYSTEM DEPRESSURIZES AND SCRUBS PARTICLES FROM A DROP CEILING.....	2-6
FIGURE 2.3.3: SEALING PROCESS DISPLAYED ON COMPUTER SCREEN.....	2-7
FIGURE 2.4.1: MEASURING RETURN PLENUM WET AND DRY BULB TEMPERATURES.....	2-8
FIGURE 2.4.2: MEASURING OUTSIDE TEMPERATURE .....	2-9
FIGURE 2.4.4: MEASURING REFRIGERANT PRESSURES .....	2-9
FIGURE 2.4.3: MEASURING SUCTION LINE TEMPERATURE WITH A CLAMP ON THERMOCOUPLE ...	2-9
FIGURE 2.8.1: SIDE-MOUNT ECONOMIZER .....	2-12
FIGURE 2.8.2: DAMPER AND SENSOR MODULE.....	2-12
FIGURE 2.8.3: TEMPERATURE PROBE .....	2-12
FIGURE 2.8.4: ENTHALPY SENSOR .....	2-13
FIGURE 2.8.5: MINIMUM-AIR POTENTIOMETER.....	2-13
FIGURE 2.8.6: AIRFLOW THROUGH A TYPICAL ECONOMIZER.....	2-14
FIGURE 3.2.1: SENSOR LOCATIONS.....	3-3
FIGURE 3.3.1. POWER INCREASE FROM ADDED REFRIGERANT.....	3-7
FIGURE 3.3.2. DUCT LEAKAGE VERSUS TIME DURING AEROSOL SEALING .....	3-8
FIGURE 3.5.1 SITE #1 SENSIBLE EER .....	3-12
FIGURE 3.5.2. SITE #6 SENSIBLE EER .....	3-12
FIGURE 3.5.3. SENSIBLE EER % IMPROVEMENT.....	3-12
FIGURE 3.5.4. SAVINGS DUE TO RETURN SEALING.....	3-14

## EXECUTIVE SUMMARY

---

Space conditioning equipment used to provide thermal comfort and adequate indoor air quality for residential and commercial buildings consumes 39% of the total energy used in buildings. At the same time it represents a disproportionate percentage of the peak electrical consumption that drives the need for increased generating capacity and more expensive distribution and transmission systems. Improving the efficiency of this equipment can set in motion significant reductions in both peak and overall energy usage. Improvements in efficiency are possible not only through new equipment technologies, but also by ensuring proper performance of existing units. Proctor Engineering Group, Ltd. and Carrier-Aeroseal LLP have implemented programs to address major sources of inefficiency in HVAC systems. This project, sponsored by the National Energy Technology Laboratory, a division of the U.S. Department of Energy, aims to transfer these technologies to the light commercial market. The result is a comprehensive diagnostics and improvement package aimed at significantly improving the performance of HVAC systems in light commercial buildings.

Vast improvement potential exists in the target building sector. Previous studies have identified several major problem areas requiring attention:

- Duct leakage and existing duct insulation levels cause an average loss of 37% in overall cooling efficiency. Reasonable improvements through effective duct sealing can eliminate over half of these losses.
- Airflow across the indoor coil is frequently insufficient for optimal performance. The average performance degradation for low airflow is 7%. Proper installation and maintenance procedures can significantly improve airflow levels.
- Refrigerant charge in existing HVAC systems is often at an incorrect level for ideal performance. The average efficiency loss is 13%. This loss can be completely regained through proper diagnosis and adjustment.
- Economizers, while designed to save energy costs by utilizing outdoor air at appropriate times, generally perform well below expectations. Studies show economizer failure rates exceeding 60%. A protocol for identifying and fixing common economizer problems can significantly improve system performance.

This project broadened and refined several efficiency improvement technologies for existing light commercial HVAC systems. These technologies include:

- An aerosol-based duct sealing technology that allows the ducts to be sealed remotely. Remote sealing is especially important for light commercial facilities, in which removal of ceiling tiles can hinder normal business practices.
- A computer-driven diagnostic and improvement-tracking tool for duct installations. This tool required some procedural modifications to apply to the light commercial market.



- An integrated diagnosis verification and customer satisfaction system utilizing a combined computer/human expert system. The system brings efficiency-critical HVAC parameters to their optimized values. This system is used to ensure proper refrigerant charge and airflow.
- A combustion appliance safety protocol for the light commercial market. The system addresses rooftop units and water heaters that may be influenced by pressure changes altered by duct sealing.

The following objectives were achieved:

- A stand-alone HVAC data lookup software was created. The software accesses a comprehensive database of air conditioners and provides capacity, efficiency, and year of manufacture based on make and model.
- A diffuser sealing system was refined and integrated with the AeroSeal duct sealing protocol. The system is now applicable to light commercial duct systems.
- A new economizer diagnostic protocol was created. This protocol provides an appropriate level of diagnostics for widespread application by existing HVAC technicians.
- A cross-reference strategy was developed for sharing data between AeroSeal and CheckMe!.
- An implementation protocol was generated. The protocol combines CheckMe! and AeroSeal analyses as well as combustion safety and economizer diagnosis.

The study team paid careful attention to making the procedure time efficient and to keeping the tasks within the capabilities and skill sets of typical HVAC contractor personnel. Together, the protocols in this package are expected to achieve an 18% to 45% savings<sup>1</sup> of HVAC energy use.

Site monitoring was performed to measure the energy savings for particular cases. Data collected from six sites in the Sacramento, CA area in the fall of 2003 and summer of 2004 demonstrated anticipated savings with one exception. That exception was a unit that had a level two problem (restriction in the liquid line). The units with duct sealing showed savings that increased with increasing outside-inside temperature difference. The savings are largest under peak conditions. The following improvements were documented:

- Improved sensible EER: The improvement averaged 18.2%, at a 30°F outside-inside temperature differential.
- Reduced heat gain in the return duct: Duct sealing eliminated return side sensible heat gains equivalent to an average of 12.4% of the system's sensible capacity, at a 30°F outside-inside temperature differential.

These results provide evidence that the comprehensive protocol is effective in reducing light commercial HVAC energy use and peak demand.

---

<sup>1</sup> The highest level of savings will occur in units with economizers and/or significant duct leakage.

# I. INTRODUCTION

---

## 1.1 Background

Light commercial buildings, primarily one- and two-story buildings with individual rooftop HVAC (Heating, Ventilating and Air Conditioning) units serving less than 10,000 ft<sup>2</sup> of floor area, make up a significant portion (approximately 50%) of the non-residential building stock in the U.S. (CBECS, 1995). Commercial retail strip-malls are among the largest percentage of light commercial buildings. This stock also includes offices, restaurants and professional buildings.

Light commercial buildings typically use constant air-volume rooftop HVAC units, applying the same ductwork and installation techniques found in residential systems. They are generally “un-engineered” systems and it is acknowledged by the construction industry that first-cost dominates construction practices. This leads to short cuts in construction practices and/or the use of lower-grade materials. In the case of ductwork this shows up as sloppy connections, inexpensive leaky diffusers, and low-grade duct tapes. With respect to the HVAC equipment this leads to installations and service techniques that produce degraded equipment performance.

One of the reasons that these practices persist is that HVAC service contractors are often driven by market forces that do not value quality work. This is true even for contractors that have the tools, knowledge, or experience needed to properly diagnose the performance of these units. There is not adequate knowledge, materials, or experience to convey the benefits of repairing the problems to building owners.

### Duct Leakage in Light Commercial Buildings

Given the amount of research concerning residential duct systems, there has been surprisingly little work on duct performance in commercial buildings. However, the work that has been performed in light commercial buildings indicates that duct leakage may be an even larger problem than for residential buildings. The recently published work in this area has come from two groups: 1) Lawrence Berkeley National Laboratory (funded by DOE, the California utilities and the California Energy Commission (CEC)) (Delp et al. 1998a, Delp et al. 1998b) and 2) the Florida Solar Energy Center (FSEC) (Cummins et al. 1996). The two most striking results from those studies are: 1) that the ducts in light commercial buildings (i.e., systems with simple rooftop package units) leak more than residential ducts and 2) that those ducts are often (approximately 50% of the time) located in ceiling plenum spaces that act very much like residential attics.

Duct leakage is typically described in any of three different ways: 1) as the fraction of the flow through the HVAC equipment that is lost, 2) as an equivalent hole size, and 3) as a leakage flow at some reference pressure, with the latter two often being normalized by either the surface area of the ductwork or the conditioned floorspace. The ductwork in light commercial buildings has been found to leak more than in residential buildings by all three yardsticks. Using the first yardstick, the work at LBNL indicates that the average supply duct leakage for 25 Constant-Air-Volume (CAV) systems was **26% of the flow through the HVAC equipment**, as compared to an average supply-side leakage of 17% in residential systems (Delp et al. 1998b). Using the second yardstick, LBNL came up with an average normalized duct leakage area for the supply and return ducts of the 25 systems of 3.7 cm<sup>2</sup> of duct leakage area per m<sup>2</sup> of floor area.

---

## Introduction

Similarly, FSEC came up with an average normalized duct leakage for 43 light commercial buildings of  $2.7 \text{ cm}^2/\text{m}^2$  (Cummings et al. 1996). The comparable duct-leakage number for attic ductwork in residences is  $1.3 \text{ cm}^2/\text{m}^2$  (Jump et al. 1996, Modera 1993). These results suggest that the normalized leakage area of light commercial duct systems is more than two times the value found in similar residential construction.

### Duct Location in Light Commercial Buildings

One reason that duct leakage in commercial buildings has been ignored is that many people in the industry feel that commercial-building ductwork is largely inside the building. However, the ceiling cavity in which this ductwork is typically located is not necessarily inside the building's thermal and air barrier. Research performed at LBNL (Delp et al. 1998a and Delp 1998b) suggests that ceiling-cavity spaces act like residential attics approximately 50% of the time. Specifically, that research indicates that 38% of the buildings had insulation placed on the roof deck (which puts the ductwork inside the thermal barrier, while 50% had the insulation placed on the ceiling tiles (which puts the ductwork outside the thermal barrier), and the remainder had insulation on both the roof deck and the ceiling (which puts the ductwork somewhere in between inside and outside). In addition, 38% of the buildings had purposeful venting of the ceiling plenum to outside (e.g. with turbine vents). An unvented ceiling plenum with insulation on the ceiling is just like an unvented residential attic, while a vented ceiling plenum with ceiling insulation is like a vented residential attic. The bottom line is that 56% of the systems were considered to be outside the conditioned space. It is also noteworthy that light-commercial ductwork in unconditioned spaces is not unique to the Sunbelt, as evidenced by photographs taken in Madison, Wisconsin light-commercial buildings (see Figures 1.1.1 through 1.1.4).



**Figure 1.1.1:** Drugstore ceiling tiles lifted to expose ceiling-top insulation



**Figure 1.1.2:**  
Drugstore  
ductwork  
installed above  
insulated ceiling  
tiles

**Figure 1.1.3:**  
Liquor store  
ceiling tiles  
lifted to expose  
ceiling-top  
insulation



**Figure 1.1.4:** Uninsulated roof-deck



**HVAC Unit Performance in Light Commercial Buildings**

In addition to problems identified with duct installations in light commercial buildings, studies have also shown extensive problems with HVAC equipment installations, maintenance, and service. The 1999 study of commercial rooftop units performed by Proctor Engineering Group for the Sacramento Municipal Utility District (Proctor 2000) showed that the majority of the rooftop units had refrigerant charge and air flow problems at least comparable to the problems documented in residential systems (as documented in Neme et al. 1999). The CEUE study (Hewitt et al. 1992) of commercial rooftop units found that only 28% were

correctly charged. Most recently the CheckMe!® Innovative Peak Load Reduction Program for the California Energy Commission (CEC) (Proctor et al. 2003) tested 18,865 commercial air conditioners. Within the CheckMe!® field test database of commercial air conditioners, manufacturers’ standard methods identified 32% as correctly charged.

It is generally believed that commercial rooftop units do not have refrigerant charge problems because they come precharged from the factory. The results of a CEC study of commercial units less than 4 years old (Jacobs 2003) showed that only 54% of the units had correct charge. The same CEC study showed that 69% of the units had 350 cfm per ton or less of evaporator airflow (compared to a standard 400 cfm per ton for the region).

These data are summarized in Table 1.1.1.

<b>Table 1.1.1 Small Commercial HVAC Problems</b>	
<b>Problem Area</b>	<b>Frequency</b>
Indoor Coil Air Flow	69% of units less than 4 years old have airflow 350 cfm per ton or less (Jacobs)
Refrigerant Charge (Commercial)	60% are Incorrectly Charged (Proctor)
Ducts (Commercial)	Over 80% have Excessive Leakage
Malfunctioning Economizer (Commercial)	65% have Malfunctioning Economizers (Jacobs)

In addition, commercial units have one additional problem, economizers that do not save what they were designed to save or even increase energy consumption. The 1990 Integrated Resources Group study (Vick et al. 1991) found that: “None of the economizers technicians encountered in the field were operating properly. The mechanical and electrical controls for economizers had generally failed in such a way as to leave the outside air damper inoperable.” The Jacobs CEC study also found that 65% of the economizers had failed within the first four years of installation.

Refrigerant charge is routinely diagnosed by “checking the pressures”. Regardless of the widespread use of this method, it is not the method approved or recommended by the manufacturers. Airflow across the evaporator coil is not routinely addressed unless it is so bad that the coil is freezing up. In addition, the technician is “on their own” with respect to what they do to a rooftop unit during maintenance, service, or checkup visits. In short there is no effective feedback loop. The work done is governed by vague “check lists” that provide insufficient guidance. The major problem is that there is no systematic method, enforced through a feedback loop that ensures the performance of rooftop commercial units.

### **Economizers in Light Commercial Buildings**

Economizers serve a simple purpose—allow outdoor air into the HVAC system when there is a need for cooling and the outdoor conditions are appropriate to satisfy or contribute to satisfying that need. In addition, economizers provide a source of ventilation to meet code requirements. To address these issues, economizers are often installed on packaged rooftop units. Economizers are in fact mandated by code in some areas of the country for packaged rooftop units (generally in the larger sizes). The economizer is a combination of sensors, controller, actuator, and an adjustable damper that can determine the percentage of outside air that enters the building.

Although the basic functions of economizers are relatively simple, many factors can contribute to economizer failure. HVAC companies typically focus on non-invasive preventative maintenance on rooftop units, including filter changes, belt replacements, checking contactors, and checking refrigerant pressures. These procedures often do not address economizer functionality. Economizer failure is a significant problem in light commercial systems. Typical failures include rusted linkages that prevent the opening and closing of dampers, sensor failures, incorrect settings, or disconnected controls.

Energy waste due to malfunctioning economizer operation can greatly exceed the economizer’s potential benefit. In some climates, the economizer may save only 5% on energy use, but can waste up to 50% when malfunctioning. Clearly, economizer diagnostics are an essential portion of any comprehensive HVAC maintenance procedure.

## II. COMPREHENSIVE PROTOCOL

---

The procedures developed for the light commercial HVAC diagnostics and improvement protocol include combustion safety testing, AeroSeal duct diagnosis, AeroSeal duct sealing, CheckMe! economizer diagnosis, CheckMe! charge diagnosis, and CheckMe! airflow diagnosis. Prior to this project, some of these technologies had already been successfully implemented in both residential and commercial programs throughout California and other states.

### **2.1 AeroSeal**

In response to early findings that duct sealing costs were dominated by labor costs, including the cost of measuring the leakage before and after sealing, a technology that seals residential ductwork from the inside was developed at Lawrence Berkeley National Laboratory (LBNL) (Modera et al. 1996). The basic technology involves pressurizing ductwork with a fog of small sealant particles. By temporarily blocking off the registers and the HVAC equipment, the fog is forced to leave the duct system at the leaks, thereby depositing sealant particles at the leaks. By appropriate choice of particle size, duct pressure and duct flow, the particles are predominantly kept suspended until they reach the leaks, and then deposited on the duct walls at the leaks due to the high velocities and sharp turns associated with air blowing through the leaks.

Carrier-AeroSeal holds an exclusive license from LBNL to commercialize the aerosol-sealing technology in residential and commercial buildings. AeroSeal franchises the technology to HVAC contractors, who have performed more than 10000 aerosol-sealing jobs around the country. In addition to these sealing jobs, the aerosol-based sealing technology has been field tested in a controlled manner in residences in Florida (Modera et al. 1996) as well as in several other states around the country (EPRI 1997). The Florida study focused on houses with ducts in the attic, and was conducted by personnel in the Florida Power and Light (FPL) duct retrofit program. That study, which included sealing of 50 duct systems and complete data on 36 duct systems, demonstrated significant labor savings (>50%) as well as increased levels of sealing, and also demonstrated that sheetmetal, ductboard and flexduct systems could all be sealed. LBNL staff performed the second study for EPRI, which encompassed sealing of 23 houses in Pennsylvania, Oklahoma, New Jersey, Connecticut and Massachusetts. That study confirmed that the sealing could be successfully performed in all of the different types of duct systems encountered.

The other existing technologies utilized in this project include software-based expert systems that aid contractors in diagnosing problems with HVAC installations. The AeroSeal diagnostic tool utilizes a simplified test that diagnoses residential duct leakage in less than 10 minutes, as well as measurements of all register flows and temperatures to diagnose problems with the distribution of heating and cooling delivery. In addition, the AeroSeal software tool analyzes the adequacy of return registers and the potential for back-drafting combustion appliances (fireplaces, furnaces or water heaters). The AeroSeal program records all of the data taken during the diagnostic process as well as during the sealing process and automatically transfers that data to AeroSeal's central computer via the Internet. This allows AeroSeal to track the performance of both diagnosticians and technicians, and provide feedback to the contractor organization.



**Figure 2.1.1:** Aerosol sealing machine, computer-control suitcase, and diagnostic tools (flow capture hood, and infrared laser-guided temperature-measurement gun)

## **2.2 Aerosol Light-Commercial Diagnostic Protocol**

### **Leakage Diagnostic Analysis**

The “House-Pressure-Test” (HPT) methodology is used within the Aerosol software diagnostic tool for screening houses for duct leakage. This test measures changes in house pressure associated with operating the HVAC fan and uses those changes to determine whether a given house has enough duct leakage to merit sealing. This screening tool is preferred in the residential Aerosol protocol because it takes considerably less time and equipment to perform. However, comparing the HPT methodology with an automated fan-pressurization test in light commercial buildings suggests that the fan-pressurization methodology is a more practical screening tool in the light commercial sector.

There are several key issues that make the HPT methodology impractical in light commercial buildings. First, the fundamental premise behind the HPT method is that it senses leakage to or from outside the air pressure boundary of a building. More than half of the light commercial buildings that can benefit from duct sealing contain ductwork that is inside the air pressure boundary of the building, but outside the thermal boundary (i.e. insulation) of the building. Moreover, even for the light commercial buildings that have duct leaks outside the air pressure boundary, the HPT method depends upon a predictable level of leakage in the building shell, which is very difficult to obtain from existing data for light commercial buildings.

The HPT methodology can be used for ducts inside the air pressure boundary if the space with the ducts (typically the ceiling plenum) is modified to communicate with the outdoors. However, in many instances it would be easier to perform the standard fan pressurization test, as opposed to creating an air-pressure link between the ceiling plenum and outdoors.

Finally, the HPT methodology requires that the exterior doors and windows in the structure remain closed for approximately 10 minutes, which is usually not a problem in residences. On the other hand, commercial building operators generally do not want to turn away customers for 10 minutes during business hours.

One alternative HPT-type methodology that was contemplated was to measure the pressure change in the ceiling plenum relative to the conditioned space when the HVAC fan is turned on. The problems with this alternative are: 1) that technicians need to visually inspect the entire ceiling, including ceiling tiles

above locked closets or offices, and 2) that a simplified reliable methodology for determining ceiling-plenum tightness levels would need to be developed.

### Fan Pressurization Methodology

The automated fan-pressurization test seems to be the best methodology for screening for duct leakage in light commercial buildings. This test is actually easier to perform in light commercial buildings as compared to in residences. There are several reasons for this including: 1) there are less supply and return grilles in light commercial buildings, 2) the grilles are generally more accessible in light commercial buildings (except in high-ceiling retail stores), and 3) pressurization equipment can be easily connected to HVAC equipment on the roof without disturbing the occupants. Pictures that illustrate both the diagnostic and sealing protocol are presented in Appendix B.

The light-commercial duct leakage testing protocol is as follows:

1) Seal all supply and return grilles using one of the following techniques:

- a) **For ferrous perforated-plate grilles:** Tape all the edges using plastic film tape (or masking tape or other temporary tape) and then install a flexible magnetic sheet (at least 1/16" thick) that overlaps the tape by at least 0.5 inches on each side. The tape may also be applied after the magnet has been applied (see Figure 2.2.1).
- b) **For ferrous grilles with flat profiles and solid metal borders:** Install a flexible magnetic sheet (at least 1/16" thick) that covers the opening, and is in good contact with at least 2 inches of flat metal on all sides of the opening.
- c) **For non-ferrous grilles (perforated plates or other flat grilles):** Install a thin galvanized sheetmetal, plastic or cardboard panel that can slip between the diffuser and the "T-bar" support on three sides, and then tape the fourth side, and any other sides with potentially uneven or leaky contact. Cardboard can also be taped to the diffuser without having to slide it under the T-bar supports.
- d) **For diffusers with removable fins or a hinged perforated grate:** Remove the fins (or open the hinged grate) and then use either: 1) use method b), 2) insert a closed-cell foam plug (see Figure 2.2.2), or 3) tape over the entire opening area.
- e) **For any diffuser:** tape over the entire opening area.



Figure 2.2.1: Plastic film tape above and below a magnetic sheet - diffuser prepared for sealing.

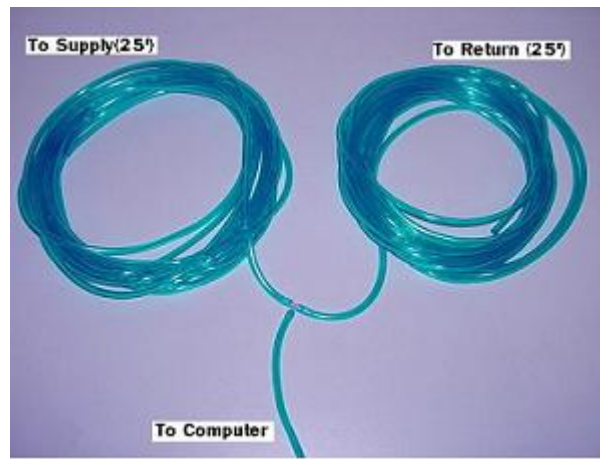

Figure 2.2.2: Foam plug in the central discharge of a hinged diffuser.



- f) **CAUTION:** Some diffusers are not mechanically fastened to the “T-bar” hangers, which can cause problems with sealing the diffuser for testing, thereby producing elevated estimates of leakage levels. “Loose” diffusers should be visually inspected by lifting adjacent ceiling tiles.
  - g) **NOTE:** Some of the temporary sealing measures described above are not suitable for aerosol sealing, and therefore should only be used for diagnostic purposes.
- 2) Connect the AeroSeal fan box or a Duct Blaster to the duct system using one of the following techniques:
- a) **For rooftop units with accessible side discharge doors:** Install flanges on one or both access doors and connect the fan-box to the flange or flanges using layflat tubing, and a “wye” if using two flanges.
  - b) **For any system:** Install a flange(s) onto a return grille and/or a supply grille connected to a large duct (i.e. 10” diameter or larger) and connect the fan-box to the flange using layflat tubing, and a “wye” if using two flanges.
- 3) Seal any outdoor air intakes, including economizers in the closed position, with tape, usually Ductmask™, a wide periodically-perforated plastic-film tape.

- 4) Attach the **blue duct-pressure tube** to the duct system via a tee going to either: 1) a supply diffuser and a return diffuser, or 2) the supply and return plenums (see Figure 2.2.3).
- 5) Attach the **red gate-pressure tube** to the AeroSeal fan-box or to the Duct-Blaster.
- 6) Run the **Pre-seal test** in the AeroSeal software application, assuring that the gate setting on the computer screen matches the gate position on the fan-box (or DuctBlaster plate plus one (i.e. DuctBlaster (DB) plate 3 = gate 4, DB plate 2 = gate 3, DB plate 1 = gate 2, and no-plate = gate 1). Note that when using a Duct Blaster, the coefficients in the input file for the AeroSeal software application (AeroSeal.in) need to be modified. Note also that a special cable is required for the software application to be able to control the flow through the DuctBlaster fan. The DuctBlaster or the AeroSeal fan box can be used to perform a pre-seal test, without control by the software application, simply by using the manual speed control on the fan to get the duct pressure to be 25 Pa.



**Figure 2.2.3:** Equal length tubing averages supply and return-side duct pressures during testing and sealing.

### 2.3 AeroSeal Light-Commercial Sealing Protocol

The AeroSeal sealing methodology for light commercial buildings is similar to the residential sealing protocol, differing principally in the details for temporarily sealing diffusers during aerosol injection, and in the use of a specific system for isolating occupied spaces from aerosol particles. This particular isolation system can also be applied in certain residential applications, namely basements with drop ceilings similar to those found in light commercial buildings.

The light-commercial duct leakage sealing protocol is as follows:

- 1) Seal all supply and return grilles using one of the following techniques:
  - a) **For ferrous perforated-plate grilles:** Install a flexible magnetic sheet (i.e. 22.5" by 22.5" sheets for "two-by-two" diffusers, at least 1/16" thick) and then apply plastic film tape on all edges of the magnet, covering the magnet, the T-bar, and the gap between the T-bar and the magnet.
  - b) **For ferrous grilles with flat profiles and solid metal borders:** Tape the opening using plastic film tape, and then install a flexible magnetic sheet (at least 1/16" thick) that covers the opening, and is in good contact with at least 2 inches of flat metal on all sides of the opening.
  - c) **For non-ferrous grilles (perforated plates or other flat grilles):** Install a galvanized sheetmetal panel that can slip between the diffuser and the "T-bar" support on three sides, and then tape the fourth side and all junctions between the T-bar and the metal plate with plastic film tape. If the diffuser can lift easily off the T-bars, tape all edges of the perforated plate (not to the T-bars) before applying the metal plate.
  - d) **For diffusers with removable fins or a hinged perforated grate:** Remove the fins (or open the hinged grate) and then either: 1) insert a closed-cell foam plug, or, 2) use method b).
- 2) Connect the AeroSeal fan box to the duct system using one of the following techniques:

- a) **For rooftop units with accessible side discharge doors:** Install flanges on one or both access doors and connect the fan-box to the flange or flanges using layflat tubing, and a "wye" if using two flanges (see Figure 2.3.1).
- b) **For light, small-tonnage packaged units:** Remove the packaged unit from the duct system (by lifting it off the curb for rooftop units) and install flanges to both plenums (or use an adapter that ties one flange to both plenums), and connect the fan-box to the flange or flanges using layflat tubing, and a "wye" if using two flanges. NOTE: Be careful not to damage the roof with the removed package unit.



Figure 2.3.1: Wye splits aerosol flow between supply and return

- c) **For units using side discharge:** Cut holes into both side discharge elbows, as would be done for duct cleaning.
  - d) **For any system:** Install a flange onto the return grille or a supply grille connected to a large duct (i.e. 10"), and connect the fan-box to the flange using layflat tubing, and a "wye" if using two flanges.
- 3) Seal any outdoor air intakes, including economizers in the closed position, with tape, usually Ductmask™, a wide periodically-perforated plastic-film tape.

- 4) Attach the **blue duct-pressure tube** to the duct system via a tee going to: a supply grille and a return grille, or the supply and return plenums.
- 5) Attach the **red gate-pressure tube** to the Aero seal fan-box.
- 6) Run the **Pre-seal test** in the Aero seal software application, assuring that the gate setting on the computer screen matches the gate position on the fan-box.
- 7) **ISOLATE THE HVAC EQUIPMENT FROM AEROSOL PARTICLES** using one of the following techniques:
  - a) **For rooftop units with accessible side discharge doors or side-discharge units with holes cut through elbows:** Block the flowpath(s) through the HVAC equipment with foam, cardboard and tape, or plastic sheeting. Note that when using plastic sheeting, it will not be able to withstand the high pressures created at the end of the sealing process. This can be accommodated by creating an “X” with duct tape on the low-pressure side of the sheet to help it withstand the pressure.
  - b) **For light, small-tonnage packaged units:** As the equipment has been removed, isolation is complete.
  - c) **For injection through grilles:** Block the flowpath(s) through the HVAC equipment with foam, cardboard and tape, or plastic sheeting at the unit itself.
- 8) **ASSURE THAT THE OCCUPIED SPACES ARE NOT SUBMITTED TO AEROSOL PARTICLES** using one of the following techniques:
  - a) Replace a ceiling tile with a tile that has been retrofitted with a flange on the bottom and a filter holder and a filter on top. The easiest way to accomplish this is by using an upside-down diffuser with a large duct flange diameter. Attach the flange to a temporary duct (typically a plastic duct core) that goes outside the building, where it is connected to a second flange mounted to a fan. The temporary duct diameter has to be large enough to maintain enough flow to depressurize the ceiling plenum. The success of this procedure depends on the tightness of the ceiling and the type of fan being used for depressurization. This procedure is made difficult to impossible by missing ceiling tiles. A “scrubber-fan” system for ceiling depressurization is shown in Figure 2.3.2.
  - b) Use a roof vent instead of a ceiling tile for attaching a fan for depressurizing the ceiling plenum. To make this technique work efficiently, all other roof vents need to be sealed, and this technique is also sensitive to missing ceiling tiles.



**Figure 2.3.2:** High-flow scrubber-fan system depressurizes and scrubs particles from a drop ceiling

- 9) **CONDUCT THE SEALANT INJECTION PROCESS USING THE AEROSEAL SOFTWARE APPLICATION**, which controls and records the sealing process. This includes recording data from the pre-seal and post-seal leakage tests, as well as minute-by-minute data on the sealing process (see Figure 2.3.3). This process can be performed in one of several ways, depending on the configuration of the equipment and duct system:
  - a) For systems where the supply and return ducts can be sealed simultaneously using a “wye” (see Figure 2.3.1), assure that the equipment is isolated from the particles on both sides and keep the blue tube installed in both sides of the duct system with the “tee”.
  - b) For systems where the supply and return sides are sealed sequentially, assure that the blue tube is located solely on the side of the system being injected.

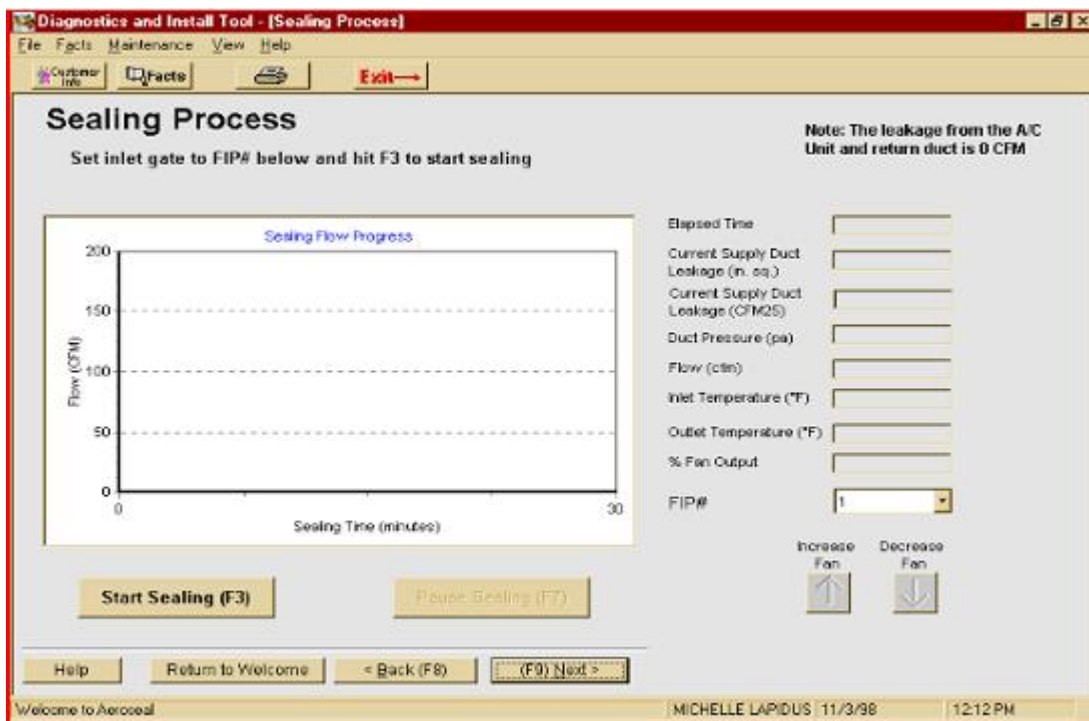

Figure 2.3.3: Sealing process displayed on computer screen.

- 10) Prepare the HVAC system for a **post-seal test**, assuring that it is in the same condition as was used for the pre-seal test (e.g. equipment leakage included).
- 11) Run the **Post-seal test** in the Aeroseal software application, assuring that the gate setting on the computer screen matches the gate position on the fan-box.
- 12) Print the certificate documenting the sealing process for the building owner, and upload the sealing process data to Carrier-Aeroseal on the monthly Internet upload cycle.

## 2.4 CheckMe!

As early as 1978 Oak Ridge National Laboratory was looking at the effect of refrigerant charge on the performance of air conditioners and heat pumps. Work by Leon Neal in the 1980's began to reveal the extent of incorrect refrigerant levels and incorrect airflow across the inside coils of heat pumps and air conditioners. Work since that time has confirmed the widespread nature of incorrect refrigerant charge, low coil airflow, leaky duct systems, and malfunctioning economizers.

The CheckMe! system, is a closed loop quality assurance routine for diagnosing, selecting appropriate treatment, verifying the application of that treatment, and confirming the final performance of HVAC equipment and systems. This system is applied to installations (to make commissioning unnecessary), to groups of existing systems to improve the "fleet average" efficiency, to systems that need to be certified, and to existing systems that are underperforming. CheckMe! consists of a specially trained technician with standardized processes and performance expectations. The technician is linked via mobile telephony to human experts and a computer expert system that work together in real time to ensure proper diagnosis, treatment, and performance of the HVAC system or component. The technician is on-site until the system is performing to program standards (there are some cases where the system cannot meet the standards without more costly repairs and those system are reported to the owner or manager). The CheckMe! system is a set of carefully designed and tested components working together to assure that the most important performance parameters are addressed.

### The CheckMe! Components

**Contractor accountability:** Licensed contractors are held to the CheckMe! standards. Failure to do so results in revocation of their CheckMe! license.

**Individualized field training:** Each technician receives a full day of hands-on field training, learning and running the CheckMe! diagnostic, intervention, and computer expert feedback procedure on two air conditioners, as well as observing another technician do the same. These are air conditioners in typical situations, not laboratory units. The technicians learn to do the job right by doing it right.

**Diagnostic procedure:** The CheckMe! technician, using the right equipment, employs a systematic, disciplined protocol to take the critical readings on the air conditioner. This includes:

- a) Running the air conditioner for a full 15 minutes to obtain accurate steady state measurements.
- b) Setting up the sensors in the proper locations; return wet and dry bulb temperatures in the return plenum (Figure 2.4.1), supply temperature in the supply plenum, condenser air entering temperature at the outdoor coil intake (Figure 2.4.2), suction line and liquid line temperatures using clamp on thermocouples (Figure 2.4.3), and high and low side pressure gauges (Figure 2.4.4).

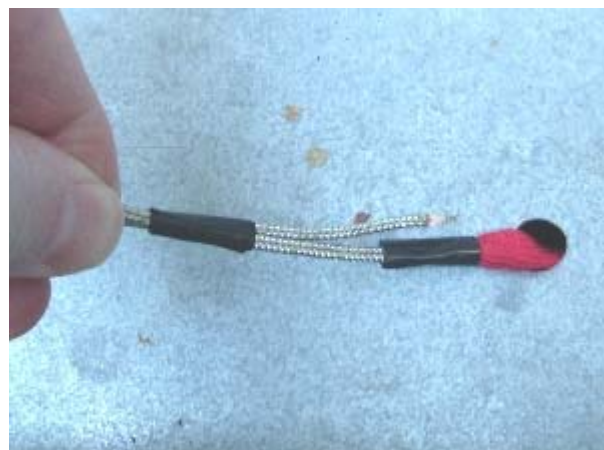

**Figure 2.4.1:** Measuring return plenum wet and dry bulb temperatures

- c) Recording initial information about the unit including; capacity, make, model, metering device, year of manufacture, etc.
- d) Measuring and recording accurate measurements at the correct time in the process.
- e) Calling the data into the expert system to verify test validity and verify diagnosis.
- f) The technician gathered information is entered into the CheckMe! Computer Artificial Intelligence program which gives the technician immediate diagnostic information. Each set of data is saved in the database, along with the resulting recommendations for repair.



Figure 2.4.2: Measuring outside temperature



Figure 2.4.3: Measuring suction line temperature with a clamp on thermocouple

- g) The CheckMe! computer program provides immediate error checking. If testing errors are present, the technician repeats the process to ensure accurate diagnoses. Experts at the center assist the technician in this process as often as needed.
- h) Once an accurate test and diagnoses is obtained the technician makes the necessary intervention (adjust refrigerant charge, improve coil airflow, etc.)



Figure 2.4.4: Measuring refrigerant pressures

- i) After the intervention, the tests are repeated and a final set of data is phoned to the center to confirm success. The initial and final third party verified results are sent to the customer to bring them into the loop.

**Technician support:** CheckMe! holds technicians in the highest regard and accountable for doing the job right. It also goes the extra mile to assure that they succeed. If the technician is having a problem in the field, the free phone call puts him on the line with an engineer or trainer who will walk him to solution. Instead of no one to turn to, or that embarrassing call to the shop, the technician has a set of national experts ready to help. This help in overcoming obstacles helps to assure that the newly trained

technicians stick with what they learned in training rather than getting into bad habits when they meet obstacles. This support also helps experienced technicians overcome old habits.

**Data collection, documentation and analysis:** The CheckMe! system, through the pre- and post-repair calls, maintains a full database of customer and air conditioner information.

**CheckMe! keeps the customer in the loop:** CheckMe! provides a certificate documenting the pre- and post-repair condition of the air conditioner. There has been over 95% positive customer satisfaction with the role of CheckMe! as third party expert verification.

## **2.5 CheckMe! Procedures**

The CheckMe! system has been successfully implemented in both residential and commercial programs. For the comprehensive protocol developed in this project 2 major additions were implemented: 1) Integrated software to determine air conditioner specifications from model number information, and 2) the economizer diagnostic protocol. The following sections describe the procedure involved with the charge and airflow protocols, the integrated HVAC data lookup and the economizer diagnostic protocol.

The real time portion of the CheckMe! system includes: screening data for errors, diagnosis, recommendations, action, follow-up, reporting, and feedback. The steps involved in this application (a CheckMe!® advanced AC diagnostic and repair) are:

- A specially trained HVAC technician uses prescribed equipment and a systematic, disciplined data collection protocol to take critical diagnostic readings on the AC equipment. The technician records the results of every test in the protocol and, directly from the job site, phones those results to a hotline.
- With the technician on the phone, operators at the hotline run the numbers through the expert system software. That software automatically screens the data for possible errors and records any errors found. If errors are detected, the technician repeats the test. The expert system diagnostic can be done at various levels. The most widely accepted application is at the level of the most frequent problems (incorrect refrigerant charge, low capacity, or low airflow). The expert system makes specific recommendations about how to correct the detected problems. The telephone call takes less than three minutes.
- The technician informs the customer of the diagnosis and, when customer approval is received, makes the repairs. This step ensures that customers are informed about the status of their equipment, the nature of the repairs required, and the expected improvements in performance and efficiency.
- After repairs are complete, the equipment is re-tested. The technician takes new readings, phones them in to the hotline for analysis, and confirmation of a successful repair.
- A certificate documenting the pre- and post-repair condition of the equipment is mailed to the customer from the independent third party provider. This provides corroboration for the technician's actions. A prepaid postcard gives the customer the opportunity to participate in a customer satisfaction survey.

## **2.6 CheckMe! Post Production**

Post-production carries forward the quality assurance and provides additional information for continuous system improvement. The post-production components include: data validation, data archiving, trend analysis, system failure alerts, and actions. When computer and human expert systems are intermeshed these features can be expanded without high labor costs.

The process includes:

- Analyzing the work of individual technicians and contractors
- Preparing reports on production and for any payments tied to performance
- Preparing quality assurance control charts
- Pinpointing technicians or contractors that need help
- Closing the loop with technicians, contractors, sponsors, and the customer
- Following up to any customers what return a less than favorable evaluation

## **2.7 HVAC Lookup Software**

As an improvement to both the real-time data acquisition and data analysis portions of the CheckMe! and AeroSeal programs, an HVAC data lookup program was developed. This program allows the user to input a model number for AC condensing units in order to obtain information on the unit's years of manufacture, SEER/EER ratings, and capacities. The program is provided to DOE as a stand-alone Microsoft Access database form. PEG and AeroSeal will integrate the software into their own protocols for obtaining the information as data are recorded at each test site.

Years covered by the database span from 1967 – 2002. The software enables “smart search” methods of locating technical information for a particular model number. As the user inputs the model number, matches are displayed on the screen. The list size reduces as more characters are entered until the user finds a suitable match. Another search method allows the user to paste an entire model number into the search field. When the search is run, likely matches are displayed in the data form that allow for missing or incorrect characters in the entered model number. This functionality was desired due to PEG and AeroSeal's experiences with older units in the field, which often have difficult-to-read model numbers due to faded or torn labels. The software allows technicians working in the field to obtain accurate capacity information for each unit, enabling accurate evaluations of airflow based on system capacity.

An installation guide for the stand-alone product can be found in Appendix E. Following this is the User's Guide in Appendix F.

## **2.8 Economizer Diagnostic Protocol**

Economizers serve two primary purposes: 1) providing “free cooling” when outdoor conditions are appropriate, and 2) providing adequate ventilation. Methods of delivering these functions vary widely between manufacturers and models. Variations include control strategy, sensor type, actuator design and damper design. Developing an effective diagnostic protocol that is applicable to all systems was challenging due to the degree of variation between different economizers.



To develop the protocol, PEG first conducted a literature search of design, installation and operation documentation. Product manuals for a variety of economizer models and common economizer components were studied to gain an understanding of how to best diagnose functionality of the economizer and track failures back to the components. Testing was performed on light commercial rooftop package units to develop and refine the protocol. Throughout the development process the goals were: simplicity, speed, and accuracy over a wide range of economizer types. The protocol evaluates basic economizer operations step-by-step, using equipment commonly available. It consists of three main elements:



Figure 2.8.1: Side-mount economizer

- 1) Economizer and control system identification
- 2) Verification of functionality and operating characteristics
- 3) Control system tuning

The Economizer Data Entry Form in Appendix C outlines the order of tasks and data collection required by the service technician. The detailed procedure follows.

#### **Economizer and control system identification**

First, the unit is inspected to identify the system make, model and control components and to observe any obvious faults such as broken linkages, blocked dampers, or disconnected controls. Information identifying the make, model, controller, and sensors is recorded on the data sheet. Linkage and actuator conditions are then observed and any obvious system fault or mechanical failure is noted. Basic maintenance activities such as cleaning and lubrication are then performed. Any problems with the system must be repaired prior to completing the rest of the protocol.



Figure 2.8.2: Damper and sensor module



Figure 2.8.3: Temperature probe

The most common sensors used on economizers are dry bulb sensors and enthalpy sensors with set point adjustments. Some examples of these are shown in Figures 2.8.3 and 2.8.4. Less common are snap-disks, which provide a simple on-off switch at a set temperature. All sensors are located, identified and recorded on the data sheet. This information is used to determine the control strategy of the economizer.

Identification of the economizer components enables the technician to determine the system control strategy. There are four basic types of control strategy:

- Single point dry bulb
- Differential dry bulb
- Single point enthalpy
- Differential enthalpy



Figure 2.8.4: Enthalpy sensor

Differential controls operate the economizer based on the relationship between the outdoor air conditions and the indoor return air conditions. If the outdoor air is of lower temperature or enthalpy than the return air then the economizer will open. Systems with differential controls are easily identified because they have one sensor for the outdoor air and another in the return duct.

Single-point controls use only an outdoor air sensor. Readings from the outdoor air sensor are compared to a set value to control the economizer. This is commonly implemented through an “A-B-C-D” temperature/enthalpy setting, adjustable thermostat-like device, or dipswitches on the controller board (such as in Trane economizers). All initial economizer settings must be noted on the datasheet, as they will be manipulated to verify operation of the economizer during this procedure.

#### Verification of functionality and operating characteristics

Once the control system has been identified the functionality of the system is tested. Simulating various operating conditions and verifying that the economizer responds appropriately accomplish this. There are four steps in the verification process:

- Verify that the economizer dampers operate through their full range.
- Estimate the % outside air introduced by the economizer at both the minimum air and fully open settings.
- Verify that the economizer moves to minimum-air or closed setting when the package unit is in heating mode.
- Check the economizer response to various conditions when the package unit is in cooling mode and measure the crossover temperature.

The economizer dampers’ range of motion is evaluated by adjusting the minimum air control to the maximum and minimum settings while the system is operating in air handler only mode. The minimum-air setting is typically adjusted by a potentiometer on the actuator or control board. The dampers should move smoothly, without catching or grinding, throughout the entire range. If the dampers fail to move properly then the problem must be corrected before completing the rest of the protocol.



Figure 2.8.5: Minimum-air potentiometer

The percent outside air introduced by the economizer is estimated based on the differential pressures across the return and economizer dampers and the areas of the return and economizer openings. The relationship is derived as follows:

The pressure drop across a damper is given by the equation:

$$\Delta p = C * \rho * (V/1097)^2 \quad \text{where:}$$

$\Delta p$  = pressure drop (inches of water)

C = Constant dependant on the geometry of the damper

$\rho$  = Density of air (lb/ft<sup>3</sup>)

V = Air velocity (ft/min)

This equation applies to both the economizer damper and the return damper.

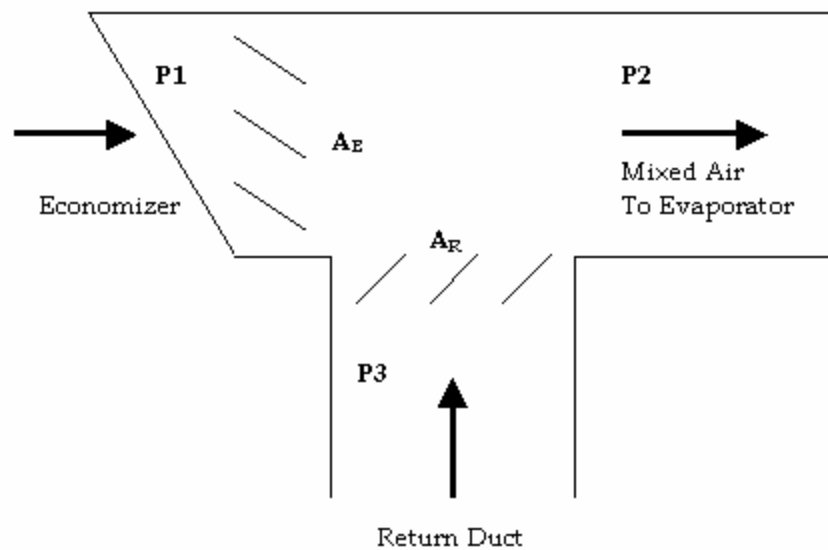

Figure 2.8.6: Airflow Through a Typical Economizer

The airflow of mixed air is the sum of the airflow through the economizer plus the airflow through the return duct:

$$CFM = CFM_E + CFM_R \quad \text{where:}$$

CFM = airflow of mixed return and outside air (ft<sup>3</sup>/min)

CFM<sub>E</sub> = airflow through the economizer (ft<sup>3</sup>/min). If expressed in terms of percent outside air then:

$$CFM_E = CFM * OSA \quad \text{where:}$$

OSA = the percentage of the mixed flow that is outside air

$CFM_R$  = airflow through the return duct (ft<sup>3</sup>/min). If expressed in terms of percent outside air then:

$$CFM_R = CFM*(1-OSA)$$

The velocity of the air in the economizer is calculated from the volumetric flow rate through the economizer and the open area of the economizer:

$$V_E = CFM_E/A_E = CFM*OSA/A_E \quad \text{where:}$$

$$A_E = \text{open area of the economizer damper (ft}^2\text{)}$$

Similarly, the velocity of the air in the return duct is calculated from the volumetric flow rate through the return duct and the open area of return duct damper:

$$V_R = CFM_R/A_R = CFM*(1-OSA)/A_R \quad \text{where:}$$

$$A_R = \text{open are of the return damper (ft}^2\text{)}$$

Applying the pressure drop calculation to both the return and economizer dampers:

$$\Delta P_R = C_R*\rho_R*(V_R/1097)^2 = C_R*\rho_R*[CFM*(1-OSA)/(A_R*1097)]^2 \quad \text{where:}$$

$$\Delta P_R = P_3 - P_2 = \text{Pressure drop across the return damper (inches of water)}$$

$$C_R = \text{Return damper constant}$$

$$\rho_R = \text{Density of return air (lb/ft}^3\text{)}$$

$$\Delta P_E = C_E*\rho_E*(V_E/1097)^2 = C_E*\rho_E*[CFM*OSA/A_E*1097]^2 \quad \text{where:}$$

$$\Delta P_E = P_1 - P_2 = \text{Pressure drop across the economizer damper (inches of water)}$$

$$C_E = \text{Economizer damper constant}$$

$$\rho_E = \text{Density of economizer air (lb/ft}^3\text{)}$$

Solving for CFM:

$$CFM = \Delta p_R^{.5*} A_R*1097/[C_R*\rho_R*(1-OSA)]$$

$$CFM = \Delta p_E^{.5*} A_E*1097/[C_E*\rho_E*OSA]$$

Equating the two:

$$\Delta p_R^{.5*} A_R*1097/[C_R*\rho_R*(1-OSA)] = \Delta p_E^{.5*} A_E*1097/[C_E*\rho_E*OSA]$$

If it is assumed that:

$\rho_R = \rho_E$  (Assumes that the difference in density between the return air and the economizer air is insignificant. A 20°F temperature difference between the return air and the economizer air

would result in a difference in densities of less than 4%. A 100 Pa pressure difference would result in a difference in densities of less than 0.1%)

$C_R = C_E$  (Assumes that the return damper is of similar geometry to the economizer damper. The constant is a function of the damper blade angle and the ratio of the sum of the damper blade lengths to the perimeter of the duct.)

Then:

$$\Delta p_R^{.5} A_R / (1 - OSA) = \Delta p_E^{.5} A_E / OSA$$

$$OSA * \Delta p_R^{.5} A_R = (1 - OSA) * \Delta p_E^{.5} A_E$$

$$OSA + OSA * (\Delta p_R^{.5} A_R) / (\Delta p_E^{.5} A_E) = 1$$

$$OSA * [1 + (\Delta p_R^{.5} A_R) / (\Delta p_E^{.5} A_E)] = 1$$

$$OSA = 1 / [1 + (\Delta p_R^{.5} A_R) / (\Delta p_E^{.5} A_E)]$$

Measuring the precise area of the openings in the economizer and return dampers at the minimum air and fully open settings can be very difficult. For the purpose of estimating the percent outside air introduced by the economizer it is much simpler to estimate the percentage of the total area (economizer + return) that each opening represents.

$$R_R = A_R / A_T \quad \text{and}$$

$$R_E = A_E / A_T \quad \text{where}$$

$R_R$  = the percentage of the total area contributed by the return opening

$R_E$  = the percentage of the total area contributed by the economizer opening

$A_T$  = total area (ft<sup>2</sup>) =  $A_R + A_E$

Using these easily estimated percentages the equation for percent outside air becomes:

$$\% \text{ Outside Air} = \frac{1}{1 + \frac{R_R \Delta P_R^{0.5}}{R_E \Delta P_E^{0.5}}}$$

Pressure readings are taken with a digital pressure gauge when the economizer is in the minimum-air and fully open modes. The return air and mixed air static pressures are measured and recorded at each setting. Estimates of the relative areas of the economizer and return openings are also made at each setting. If the pressures cannot be measured or the relative areas of the dampers cannot be estimated then this method will not work. For most economizers, however, the return and mixed air ducts are accessible and pressure readings can be easily taken by drilling a small hole in each duct and inserting static probes. Likewise, the dampers in most economizers are sufficiently accessible for an accurate estimation of the relative areas to be made.

Next, the economizer response in heating mode is observed. This is accomplished by returning the minimum air setting to its original value and operating the unit in heating mode. The economizer

dampers should move to the minimum air position. Failure of the economizer to close to the minimum air setting during heating can waste a tremendous amount of energy. An economizer that remains fully open during heating is termed a “wild economizer” and can increase energy bills by 50% or more as it expends energy heating cold outdoor air.

The economizer response in cooling mode is verified by manipulating the sensors while the unit is operating in cooling mode. This procedure ensures that the sensors are functioning properly, that they are communicating with the controller, that the controller is responding properly to the sensor inputs, and that the controller is communicating with the actuator.

First, the package unit is placed in full cooling mode and allowed to run until the economizer reaches a steady position. The economizer position at this point could vary from the minimum air position to fully open depending on the outdoor conditions and controller settings. Next, a small bag of ice is placed over the outdoor sensor. This method of cooling the sensor is easy, inexpensive, and very effective. As the sensor is cooled the economizer damper should move to the fully open position, or remain fully open if it was already in that position. Next, the system should shut off the compressor, going into “free cooling” mode. Multi-stage systems will shut down one stage at a time, using the outside air as the first stage of cooling. When the sensor has cooled sufficiently all compressors should shut off. As the sensor cools further (usually below 55°F) the system should begin to modulate the position of the dampers to prevent the mixed (supply) air temperature from being too cold.

If the system fails to respond appropriately to the cooling of the outdoor sensor then the mode of the failure is useful in directing troubleshooting activities. For example, one unit that was tested shut off the compressor as the sensor cooled but failed to open the economizer damper. Clearly the sensor was functioning and communicating with the controller, the controller was functioning and communicating with the compressor but the economizer failed to respond. The problem was found to be a faulty actuator relay.

Once proper economizer response during cooling of the outdoor sensor has been verified, the ice is removed and the sensor is allowed to warm up. For probe-type sensors, a pipe-clamp thermocouple is placed over the sensor to measure the temperature of the probe. For newer Honeywell sensors that are enclosed in a plastic case the current through the sensor leads is measured (in mA) and the temperature calculated based on the sensor model number. When the sensor warms to the crossover temperature the compressor will turn on and the economizer damper should return to the minimum air position. This temperature (or amperage) is noted on the data sheet. If the sensor warms up too quickly to accurately measure the crossover point then the procedure is repeated with the sensor insulated so it will warm more slowly. If the ambient temperature is too cold for the sensor to reach the crossover point then the sensor is warmed artificially with a work lamp or other mild heat source.

The measured crossover temperature should match the controller setting for single point control systems that use dry bulb type sensors. For differential control systems that use dry bulb sensors the crossover temperature should be equal to the return air temperature. This technique cannot be used with enthalpy type sensors because cooling the sensor can cause condensation to form, resulting in an incorrect humidity reading.

### **Control system tuning**

The final step in the protocol is tuning the control system for optimal performance. Economizer settings are often either left at the factory setting or set by the installer’s “best guess”. System performance and efficiency can frequently be improved by adjusting the economizer settings in an informed manner to match the requirements of the system. Ideal settings will vary depending on building characteristics, climate, occupants’ preferences, and local building codes.

Minimum air settings are determined by the ventilation requirements of the building, as defined in the local building code. The flow rate of outdoor air is commonly estimated based on the temperatures of the return air, the ambient air, and the mixed air when the unit is operating in ventilation only mode. This method is effective when there is a large difference between the ambient air temperature and the return air temperature but fails when the temperature difference is small. Frequently the flow rate of outdoor air isn't measured at all and the economizer minimum air setting is purely a guess. The percent outside air estimate calculated in this protocol provides a good evaluation of the amount of outside air delivered by the economizer and is effective in verifying that the system satisfies ventilation requirements without allowing excessive outdoor air into the building. Unlike the traditional approach, the accuracy of this method is not dependant on a large delta between the outdoor air and return air temperatures.

Ideal temperature settings will also vary depending on the building characteristics, occupant's preferences and building codes. Differential control systems do not require adjustment since their operation is referenced to the return air temperature or enthalpy. It must be verified, however, that differential systems are set to the differential control setting. An aggressive (warm) setting is recommended for the crossover temperature for single sensor control strategies but this setting must not exceed the average thermostat set point in the building. California's Title 24 defines high temperature/enthalpy shut-off limits depending on climate zone and control system type. Title 24 also prohibits single point enthalpy controls in certain climate zones.

**Table 2.8.1** Title 24 Economizer Control Requirements

Control System Type	Climate Zones	High T, h Shut-off Limit
Single Point Dry Bulb	1,2,3,5,11,13,14,15,16	Outside temperature > 75°F
	4,6,7,8,9,10,12	Outside temperature > 70°F
Single Point Enthalpy	4,6,7,8,9,10,12	Outside enthalpy > 28 Btu/lb
	1,2,3,5,11,13,14,15,16	This control system prohibited

Final economizer settings are documented on the data sheet for comparison to the initial settings. This completes the protocol. Repairs and changes to the system settings should be communicated to the building owner or manager, as should any recommended improvements to the system.

## 2.9 Combustion Safety Protocol

Leaky duct systems and unbalanced supply and return airflows affect pressure balances within homes and commercial buildings. There is the potential for leaky supply ducts to create a negative pressure in the building, drawing gases created by combustion appliances into the occupied spaces within the building. Similarly, significant airflow resistances between rooms with return grilles and rooms without return grilles can create negative pressures in the rooms with the returns. As part of the duct sealing program, PEG/Aeroseal requires testing of combustion safety in all buildings where duct sealing is to be performed. The data sheets for combustion safety can be found in Appendix A. When duct sealing is concentrated on the return airside of the system, the amount of building depressurization can increase.

The basic concept of this protocol is to test for and ensure complete combustion with a minimum of CO production, as well as to test for and ensure proper venting of the combustion appliances. The tests are performed twice. One test occurs prior to duct sealing so that existing problems are repaired before sealing is undertaken. The second test is post-repair to assure that the sealing has not produced an unsafe situation.

The following standards provide the basic criteria to be met in the Combustion Safety Test. Buildings are not considered complete until the form is filled out completely and correctly and all repairs are completed and verified by retest. Since duct sealing will reduce the dilution of contaminants in the indoor air, strict compliance with these criteria is necessary.

### **Procedures and Work Flow**

The Combustion Safety Test Procedure Form guides the technician through the following tests:

- 1) Tests for gas leaks for protection from fire, explosion and excessive fuel consumption.
- 2) Tests for the presence of Carbon Monoxide (CO) in the combustion products. These tests ensure that there is no source of CO sufficient to cause illness or death should combustion products enter the building. These tests also ensure the complete combustion of the fuel to provide maximum heating efficiency.
- 3) Tests for combustion product leakage into the building from vented appliances. These tests ensure that the health and safety of occupants is not compromised by the presence of combustion products from appliances that are designed to be vented.
- 4) Visual tests for leaks in the furnace heat exchanger for protection from combustion products entering the building.
- 5) Test of combustion zone pressures relative to the outdoors, with and without exterior doors closed.

The safety tests shall be performed in the following manner:

- 1) All exhaust fans shall be operating.
- 2) All exterior doors and windows shall be closed. All interior room doors shall be open.
- 3) Where multiple appliances use a common vent the test shall be run with all the common vented appliances operating.
- 4) For appliances in spaces too small to allow the Technician to be present in the room with the door closed the following applies:
  - a. The closed door test will be performed by inserting an extension tube into the vent pipe that then allows testing of the CO content and draft measurement in the vent pipe with the door closed.
  - b. The open door test shall be performed as usual.

### **Performance Standards**

Each building should have both pre- and post-retrofit Combustion Safety Tests performed on the furnace and water heater. The pre-retrofit tests establish that the appliances are operating in a safe manner before the retrofits take place. Since the work that the maintenance crew will do can affect the combustion product content and venting, the same tests are also performed after work is complete.

All appliances must meet the following criteria prior to and after duct sealing:



- 1) No significant gas leaks.
- 2) On vented appliances, no combustion product spillage at 5 minutes.
- 3) Less than 100 ppm CO in flue gas.
- 4) Adequate draft as specified in the production form.
- 5) No detectable flame interference from furnace fan.
- 6) No continuous flame roll-out.
- 7) Depressurization in zones with combustion appliances of no more than 3 Pa.

### **Prescriptive Measures**

Each vented gas appliance shall have a venting system without holes, disconnects or leaks.

#### **2.10 CheckMe!-Aeroseal Integration**

Individually the CheckMe! and Aeroseal programs have demonstrated success in improving operating characteristics of both residential and commercial air conditioners. Each program is capable of tracking individual units and providing summary statistics of improvements obtained as a result of the duct sealing or AC treatment. In the development of a combined package, several issues required attention to smoothly integrate the systems. Successful implementation of both programs with effective savings tracking required the addition of several key measures:

- 1) Common contractor recruiting
- 2) Unique data identifiers
- 3) Monthly synchronization
- 4) Mutual marketing to building owners/managers

These measures are described in detail below.

#### **Common contractor recruiting**

The procedures in the Light Commercial Protocol can be separated into the following tasks:

- Aeroseal: Combustion safety, duct leakage diagnosis, and duct sealing
- PEG: Economizer, charge, and airflow diagnosis and repair

PEG and Aeroseal provide training for each of their respective programs. To implement the comprehensive light commercial protocol, single “cross-trained” contractors will perform both procedures due to 1) contractual obligations promising HVAC service contractors that PEG/Aeroseal not disclose their customers to other contractors, and 2) time-effectiveness. Using one contractor to perform the entire protocol is the most time-efficient method. All contractors performing either a CheckMe! diagnosis/repair or an Aeroseal diagnosis/repair must be certified to perform their duties. Existing certified contractors for each of the protocols will be contacted to determine their interest in participating in the combined program.

### **Unique data identifiers**

Aeroseal's protocol generates a unique identifier for each unit, while PEG's program uses a combination of contractor information, the contractor's customer ID, and the zip code of the test site to uniquely identify each data set. Extra data fields will be added to both programs to add the complementary program's identifier information. PEG's additions are as follows:

- "Aeroseal Contractor" field added to database of certified contractors.
- "Aeroseal flag" added to denote whether or not the unit being treated has already been duct-sealed. This flag appears only if the contractor is certified. The possible choices are "Yes", "No", and "Unknown".
- Aeroseal identifier string. This text field is displayed if the "Aeroseal flag" above is marked "Yes". An "Unknown" button will also be available for cases in which the Aeroseal identifier cannot be obtained.

Aeroseal's additions:

- "CheckMe contractor" checkbox added to initial data screen.
- "CheckMe! flag" added to denote whether or not a CheckMe! run has already been performed. This flag appears if the "CheckMe contractor" checkbox above is marked. The possible choices are "Yes", "No", and "Unknown".
- CheckMe! customer ID. This text field is displayed if the "CheckMe! flag" above is marked "Yes". An "Unknown" button will also be available for cases in which the CheckMe! customer ID is unavailable.

Since the service technician or building owner may not have the necessary identification numbers on hand at the site, missing data may result when the "Unknown" checkboxes are selected. On a monthly schedule, the missing data will be filled in as explained in the following section.

### **Monthly synchronization**

Monthly synchronization is necessary to obtain a full list of sites serviced by the "cross-trained" contractors, using either the CheckMe! protocol or the Aeroseal protocol. The sites on this list are separated into three categories depending on services performed: 1) CheckMe! only, 2) Aeroseal only, and 3) both. The synchronization procedure is outlined below:

- 1) Aeroseal sends PEG full list of "cross-trained" contractor runs + results (no intermediate data). The sent data includes the Aeroseal identifier along with customer information and the CheckMe! flags outlined above.
- 2) PEG synchronizes the list with all runs performed by contractors matching "Aeroseal Contractor" in its database. The synchronization follows this order to obtain matches in which both services have been performed:
  - a. PEG's "Aeroseal identifier" string
  - b. Aeroseal's "CheckMe! identifier" string

- c. Customer phone number
  - 3) The full list is generated, categorizing customers into CheckMe only, Aero seal only, or Both. Results of AC charge, airflow, and economizer testing are added to the data.
  - 4) The list is sent back to Aero seal.

Knowledge of sites in which only one of the tests was performed will enable targeting of diagnostics and intervention for the following month. The synchronization process will also allow PEG and Aero seal to have current data for savings analysis or progress monitoring.

Note that the synchronization process uses customer phone numbers as a last resort to match jobs performed. Because of the dynamic nature of phone numbers at specific sites, it is highly recommended to the service technicians to obtain the IDs of the complementary job either from the customer or their own paperwork.

#### **Mutual marketing to home/building owners**

The procedure outlined above includes determining whether or not a site previously had the complementary service performed. Although the synchronization process is possible using only customer phone numbers, it is recommended that the service technician ask the customer whether or not the other service was performed. This enables word-of-mouth explanations of the complementary program. If the customer already had the service performed, the technician will ask for the ID of the job, explaining the synchronization process necessary for the comprehensive protocol. If the customer is unaware of the complementary service, the technician will briefly describe the program and recommend having it performed. An informational sheet may be given to them explaining the benefits of either the CheckMe! or Aero seal programs for light commercial buildings.

## III. SITE MONITORING AND RESULTS

---

### **3.1 Site Selection and Diagnostics**

Energy savings associated with application of the comprehensive protocol were measured at sites in Sacramento, CA during September through November of 2003 and June through October of 2004. The sites selected were light commercial buildings in Sacramento Municipal Utility District (SMUD) service territory with 3 or fewer AC units serving a common space. The target AC capacity was 5 tons. The buildings selected had ductwork above the thermal boundary of the conditioned space.

A total of 25 sites were visited and complete diagnostics were performed on 16 of those sites. 8 sites received improvements according to the comprehensive protocol. Energy use and system operating conditions were monitored on the sites that received repairs. Contractors certified in CheckMe! and Aroseal protocols performed the repairs.

Measured equipment performance parameters (pre- and post-repair) included:

- Duct Leakage at 25 pascals
- Refrigerant Charge added or removed as a percentage of nameplate charge
- Airflow through the evaporator
- Supply and Return dry bulb temperatures
- Return wet bulb temperature
- Condenser air entering temperature
- Evaporator and Condenser saturation temperatures
- Suction and Liquid line temperatures

15 of the 16 sites diagnosed had one AC unit and one site had 3 units. The average unit size was 4 tons. One system had an economizer. The systems averaged 315 CFM of duct leakage, 22% of the airflow. 5 of the units were undercharged, 6 were overcharged and 5 were charged correctly. 2 units could be not checked for overcharge due to hot and dry ambient conditions, but were not undercharged. 3 systems had a high temperature split (indicating low airflow across the evaporator coil), 2 had a low temp split (indicating low capacity or high airflow), and 8 had temp splits that were within the target range for the test conditions. The site diagnostic results are listed in table 3.1.1.

**Table 3.1.1** Diagnostic Results

Site #	Site Description	AC Size (Tons)	Refrigerant Charge	Evaporator Airflow	Duct Leakage (CFM25)	Duct Leakage (%)
1*	Retail	3	Low	OK	184	16
2*	Office	2.5	High	OK	183	19
3*	Office	3	OK	OK	152	13
4*	Office	2	High	OK	200	24
5*	Financial firm	6	Low	OK	69	4
6*	Bar	5	High	OK	393	20
7*	Chiropractor	3	High	Low airflow	431	36
8*	Investment firm	3	OK	Low airflow	483	40
9	Engineering firm	4	OK	OK	543	34
10	Barber shop	3	OK	Low temp split	321	27
11	Club	10	High	OK	494	12
	Bar	5	Low	Low temp split	392	20
	Restaurant	5	Low	OK	389	19
12	Financial firm	5	Low	OK	130	7
13	Travel agency	3	High	Low airflow	329	27
14	Shipping store	3	OK	OK	360	30
15	Retail	4	OK	OK	200	13
16	Small business	4	OK	OK	411	26

\* Indicates sites that were monitored

### 3.2 Monitoring Equipment and Procedures

Energy use and system operating conditions were monitored at each site before and after application of the comprehensive protocol. Following is a description of the monitoring procedures and the sites that were monitored.

#### Monitoring Equipment and Procedures

Eight parameters were measured, as illustrated below.

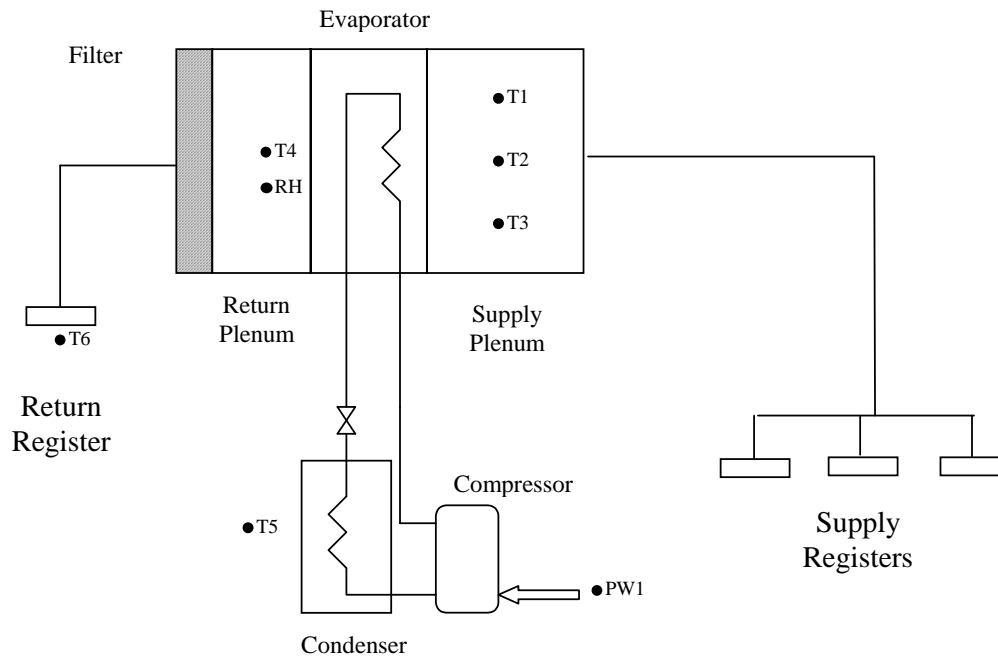

Figure 3.2.1: Sensor Locations

Table 3.2.1 Sensor Description

Sensor	Sensor Type	Description
T1, T2, T3	Thermister	Supply plenum air temperature
T4	Thermister	Return plenum air temperature
T5	Thermister	Condenser air entering temperature
T6	Thermister	Return grille air entering temperature
RH	RH sensor	Return plenum relative humidity
PW1	AC watt transducer	Outside unit electrical power, current stepped down using an AC current transformer

## Site Monitoring and Results

The watt draw was sampled every minute. Relative humidity and all of the temperatures were sampled every 5 minutes. Four HOBO data loggers were used to collect the data. The data loggers were launched from a laptop PC and synchronized to the internal clock in the laptop. The monitoring equipment is described in table 3.2.3 and table 3.2.4.

**Table 3.2.2** Monitoring Equipment

Description	Parameter Measured
HOBO H8 outdoor 4-channel data logger <ul style="list-style-type: none"> <li>• TMC6-HA Wide-range temperature sensors</li> </ul>	Condenser air entering temperature
	Supply air temperature 1
	Supply air temperature 2
	Supply air temperature 3
HOBO H8 outdoor 4-channel data logger (0 - 2.5V) <ul style="list-style-type: none"> <li>• Ohio Semitronics GH-020B watt/watt-hour transducer               <ul style="list-style-type: none"> <li>○ Ohio Semitronics 10418 current transformer</li> </ul> </li> </ul>	Watt draw of the outdoor unit
HOBO H8 Pro RH/temperature data logger	Return air temperature
	Return air relative humidity
HOBO H8 temperature data logger	Return grille temperature

**Table 3.2.3** Monitoring Equipment Accuracy

Description	Accuracy
HOBO H8 outdoor 4-channel data logger <ul style="list-style-type: none"> <li>• TMC6-HA Wide-range temperature sensors</li> </ul>	+/- 0.9 °F
HOBO H8 outdoor 4-channel data logger 0-2.5V	+/- 3%
Ohio Semitronics GH-020B watt/watt-hour transducer	+/- 2%
Ohio Semitronics 10418 current transformer	+/- 3%
HOBO H8 Pro RH/temperature data logger	+/- 0.9 °F, +/- 3% RH
HOBO H8 temperature data logger	+/- 1.27 °F

### 3.3 Site Description and Repairs

Eight of the sites diagnosed were selected for pre- and post-repair energy consumption monitoring. Selection criteria included the need for air conditioner repairs and duct sealing. Sites were also evaluated for the likelihood that they would provide consistent data throughout the monitoring period. Pre- and post-repair conditions of the monitored sites are detailed below.

**Table 3.3.1** Monitored Site Characteristics

Site #	#1	#2	#3	#4	#5	#6
<b>Description</b>	Retail	Office	Office	Office	Financial Firm	Bar
<b>Refrigerant Adjustment (oz)</b>	+40	-16	0	-24	+80	-10
<b>Refrigerant Adjustment (% of Factory Stamped Charge)</b>	39%	18%	0	28%	40%	10%
<b>Airflow Adjustment</b>	None	None	None	None	None	Cleaned filter
<b>Initial Duct Leakage (CFM25)</b>	184	183	152	200	69	393
<b>Initial Duct Leakage (%)</b>	16%	19%	13%	24%	4%	20%
<b>Initial Equivalent Hole Size (in<sup>2</sup>)</b>	35	35	29	38	13	74.5
<b>Final Duct Leakage (CFM25)</b>	79	54	104	Not Sealed	Not Sealed	58
<b>Final Duct Leakage (%)</b>	7%	6%	9%	Not Sealed	Not Sealed	3%
<b>Final Equivalent Hole Size (in<sup>2</sup>)</b>	15	10	20	Not Sealed	Not Sealed	11
<b>Supply Leakage Sealed (% of Fan Flow)</b>	7%	6.3%	4%	Not Sealed	Not Sealed	Not Reported
<b>Return Leakage Sealed (% of Fan Flow)</b>	2.2% (est)	7.4%	0%	Not Sealed	Not Sealed	Not Reported
<p>* Percentage leakage flows calculated by dividing measured leakage cfm at 25 Pa by the measured fan flow. Note that leaks may experience pressures either higher or lower than 25 Pa. (est) is based upon estimated sealing performed manually.</p>						

Sites #7 and #8 are not included because the air conditioners at those sites were not operated following repairs. Site #4 produced such a small amount of data that analysis was inconclusive.



**Site #1:**

This site has a 3-ton AC unit serving a small store. The evaporator airflow is 382 CFM/ton. This unit was undercharged, requiring the addition of 40 oz of refrigerant (39% of the factory stamped charge). The supply and return ducts were both sealed.

Refrigerant was added ahead of the original schedule because the occupants complained of insufficient cooling. The air conditioner evaporator coil was completely blocked with ice. The icing was caused by the undercharge and running all night at a very low thermostat setting (about 57°F). There are three groups of data from this system:

- Pre-repair
- Post-CheckMe! / pre-Aeroseal
- Post-Aeroseal

The energy savings associated with CheckMe! and Aeroseal are considered individually, as well as in combination.

**Site #2:**

This site has a 2.5 ton AC serving office space. The evaporator airflow is 377 CFM/ton. This unit was overcharged. 16 oz of refrigerant were removed, 18% of the factory stamped charge. The supply and return ducts were both sealed.

This unit had an electrical contactor that was stuck in the on position during the pre-repair monitoring. As a result, the compressor ran continuously. The blower cycled on and off. When the blower is off and the compressor is running the evaporator coil ices up. This limited the usefulness of the pre-repair energy use data. The effect of the return duct sealing is clear in the analysis.

**Site #3:**

This site has a 3 ton AC serving office space. The evaporator airflow is 395 CFM/ton. The supply duct was sealed by 4%. Refrigerant charge did not require adjustment. No significant savings were anticipated from this small change. No significant savings occurred.

**Site #4:**

This site has a 2 ton AC serving office space. The evaporator airflow is 415 CFM/ton. The initial diagnostic test measured 1°F of superheat with a target superheat of 8°F, indicating overcharge. The subcooling was 16°F which was consistent with a mild overcharge. 24 oz of refrigerant was removed (28% of the factory stamped charge). This repair increased the superheat to within 2°F of the target superheat and lowered the subcooling to 8°F. The ductwork was not sealed. The anticipated response to reducing overcharge is a reduction in watt draw at identical conditions and a similar reduction in capacity. The anticipated changes were expected to produce a savings of approximately 1%. The advantage of reducing overcharge at this level is reduced peak draw when the unit is running continuously, and reduced probability of failure to start at high temperatures as well as reduced potential for compressor burnout.

This unit ran infrequently and because of thermostat adjustments never cycled. It did not produce enough data for conclusive analysis given the small savings.

**Site #5:**

This site has a 6-ton AC serving office space. The unit originally served a larger space. A portion of the original space was split off to create a separate store with its own AC unit. This unit is oversized for the space it now serves. The evaporator airflow is 304 CFM/ton. The initial diagnostic test measured 50°F of superheat with a target superheat of 17°F, indicating undercharge. The subcooling was 35°F which is counterindicative. Following standard first level procedures, 80 oz of refrigerant was added (40% of the factory stamped charge). This repair reduced the superheat to within 5°F of the target superheat and maintained a very high subcooling. The ductwork was not sealed.

Level two diagnostics indicates that there is a restriction in the liquid line that is causing the combination of high subcooling when the superheat is set properly. The level one diagnostic repair was monitored with the following results:

It was anticipated that the increase in refrigerant charge would increase the power draw of the compressor and, based on level one diagnostics would increase the capacity of the unit sufficiently to improve the EER of the unit. Adjusting an undercharged unit by 40% is anticipated to save 28%.

The power draw of the unit did increase (Figure 3.3.1). The increase was in excess of 500 watts.

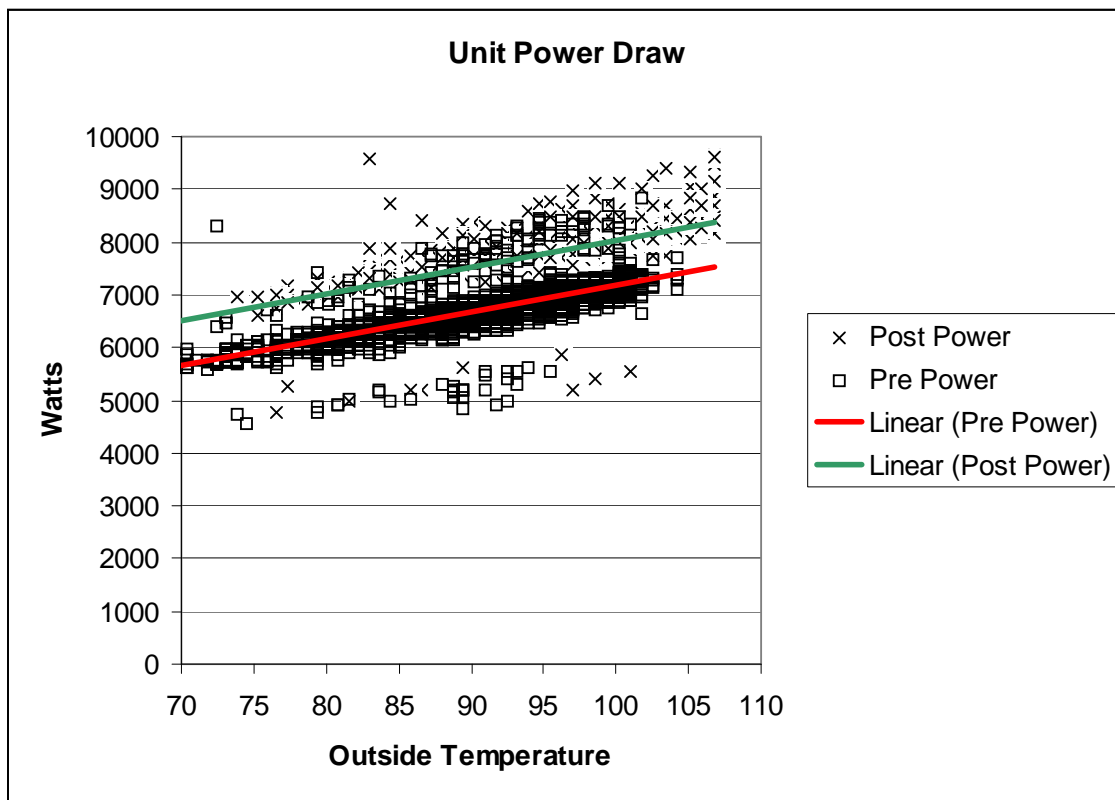

**Figure 3.3.1.** Power Increase from Added Refrigerant

At the same time the capacity of the unit also increased, but the increase was not as large as would be expected for a properly operating unit. The excess refrigerant in the condenser (as evidenced by high condenser saturation temperatures, high condenser approach, and high superheat) reduced the effective heat exchange area of the condenser. This drove up the power draw more than the increased capacity generated at the evaporator coil.

This unit produce no savings because of the liquid line restriction.

**Site #6:**

This site has a 5 ton AC serving a bar. The evaporator airflow is 273 CFM/ton. This unit was overcharged. 10oz of refrigerant (10% of the factory stamped charge) was removed. The supply and return ducts were sealed.

The ductwork at this site was caked with a large amount of dirt. The ducts needed to be cleaned before they could be sealed. The duct sealing was completed on the supply and return sides simultaneously. The supply/return split on sealing and leakage is unknown.

**Duct Sealing Data**

Shown below are minute-by-minute profiles of the duct sealing process performed at sites #1, #2, and #3. Each of these profiles shows a different characteristic of the sealing process.

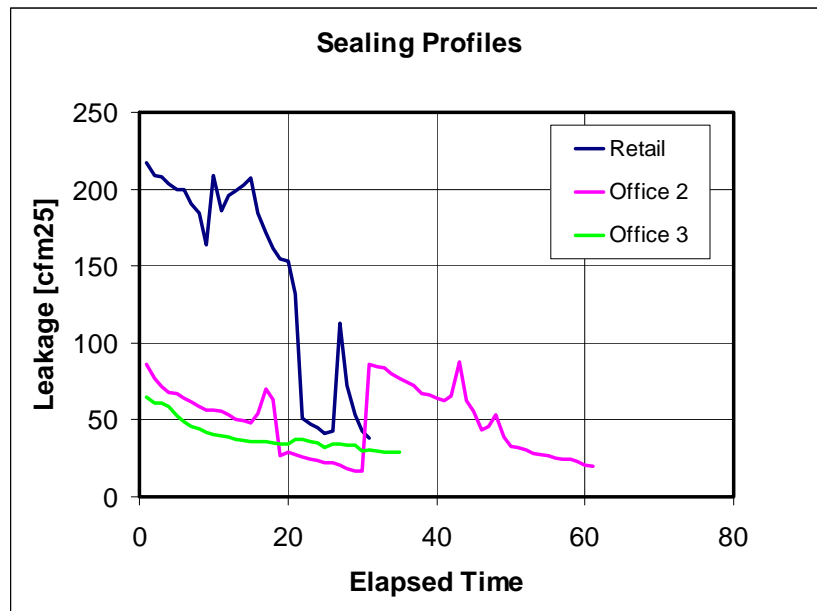

**Figure 3.3.2.** Duct Leakage Versus Time During Aerosol Sealing

For the retail site, the profile (supply side only) shows sharp spikes and drops in the measured leakage, as well as a period of slowly increasing leakage. This was due to the type of diffusers at this site, namely inexpensive diffusers that came apart as the pressure in the duct system increased. Increases in duct pressure lifted the diffuser bodies off their grates showing increasing leakage. Reductions in fan speed caused the pressure and apparent leakage to drop. The problem was solved by using foil tape to hold the diffusers to the grates/ceiling.

For Office #2, the sealing plot shows two relatively steady descents with a large increase in leakage in the middle. The first descent is the supply side being sealed, and the second is the return side. The increase in the middle is associated with moving the injection machine from the supply to the return. The spikes in this plot are due to operator errors with the equipment settings. Office #3 shows a steady decrease in leakage, the sealing rate was lower than in the other two cases due to the failure of a heater in the injection nozzle.

When interpreting the data presented in Table 3.3.1 and Figure 3.3.1, it is important to take into account several factors. In the case of Site #1 (retail), the leakage values for the return side were estimated, due to the fact that manual attachment and sealing of the return diffuser was performed both before and after the initial return leakage measurement. In all cases, the leakage flows (as a percentage of fan flow) are estimated assuming that all leaks see a pressure differential of 25 Pa (the standard test pressure). 25 Pascals may or may not be representative of the actual pressures at the leaks.

### **Economizer Function**

The simple purpose of the economizer is to utilize outside air for cooling when it is cooler outside than it is in the building. The economizer also provides a minimum of outdoor air for ventilation under all conditions.

The sequence of operation when the outside temperatures drop is as follows. The economizer is always open at least to the minimum position. When the outside temperature drops below the 1<sup>st</sup> crossover point, the economizer dampers open further to allow outside air into the return side of the system. This outside air provides free cooling. As the outside temperature drops further (below the 2<sup>nd</sup> crossover point), the compressor turns off. This provides the maximum savings since it uses no compressor based cooling. When there is no call for cooling the economizer resets to the minimum position.

### **Economizer Protocol Field Test**

The economizer protocol was tested at two sites. At one site the economizer functioned as designed.

At the other site the economizer was not functioning properly. The minimum air setting was at the maximum, providing 47% outside air. When the outside sensor was cooled below the 1<sup>st</sup> crossover point the compressor turned off and the economizer did not move. At the 2<sup>nd</sup> crossover point, the economizer opened past the minimum setting but the compressor turned back on.

Correcting the control problems so that the economizer opens when it is cool outside, and the compressor doesn't run needlessly when it is very cool outside would provide significant energy savings for this unit. Adjusting the outside air setting to a more reasonable value would also greatly reduce energy use.

### **3.4 Analysis Methodology**

In order to deal with the complexity of small commercial buildings energy consumption for cooling and sample size limitations, multiple measures were used to triangulate savings. These measures included:

- Increased capacity allowing cycling under conditions where the unit ran continuously before
- Improved sensible efficiency including the return duct section
- Reduced heat gain in the return duct (if the return was sealed)
- Calculated savings based on measured changes in unit performance parameters.

#### **Sensible Steady State Efficiency (including return duct effects)**

Sensible steady state efficiency (SenEER) is the amount of sensible cooling (Btuh) per watt when the unit has reached steady state. This efficiency changes as a function of the outside and inside conditions. SenEER decreases with increasing  $\Delta T_{oi}$ .

Many of these units had an outside air makeup in the return duct near where it entered the cabinet. Obtaining an accurate field measurement of the mixed air temperature entering the evaporator coil is virtually impossible. Therefore this project monitored the temperatures at the return before the makeup air and at the return grille. The SenEER for this project was designed to capture the effects of changes to “the box” (charge adjustment) and to the return system (return duct sealing) in a sensible EER based on the return grille temperature and the supply plenum temperature. The calculation is:

$$\text{SenEER} = (\text{Tdrop}/\text{P}) * \text{CFM} * 1.08 \text{ BTU} * \text{min} / \text{°F} * \text{ft}^3$$

Where:            Tdrop = return grille temp - supply plenum temp in °F

                      P = power draw of the system in watts

                      CFM = system airflow in cubic feet per minute

Linear regressions of the pre and post-repair SenEER vs.  $\Delta T_{oi}$  are compared to determine the savings.

This metric captures the savings from repairs to “the box” and to the return duct system.

### **Return Duct Heat Gain**

Heat gain in the return was evaluated by calculating the difference between the return plenum temperature and the return grille temperature as a function of the outside and inside conditions, at steady state. Linear regressions of the pre and post-repair return duct temperature gain vs.  $\Delta T_{oi}$  were compared to determine the savings. The increase in temperature is normalized to the sensible capacity of the system. Theoretical sensible capacity was calculated from the target temperature split as published by Carrier Corporation. The target temperature split predicts the dry bulb temperature drop across the evaporator coil for a system operating with correct refrigerant charge and correct evaporator airflow.

This metric captures the savings from repairs to the return duct system.

### 3.5 Savings Analysis

Analysis of Sites 3, 4, and 5 are in Section 3.3.

#### Sensible Steady State Efficiency (including return duct effects)

Pre and post-repair steady state sensible efficiency was compared for sites #1 and #6. The sensible EER was calculated as specified in Section 3.4.

The sensible EER vs.  $\Delta T_{oi}$  linear regression results are tabulated below in the format:

$$\text{Post-repair sensible EER} = S1 * \Delta T_{oi} + C1$$

$$\text{Pre-repair sensible EER} = (S1+S2) * \Delta T_{oi} + (C1+C2)$$

$$\text{Efficiency Improvement} = - S2 * \Delta T_{oi} - C2$$

Where  $\Delta T_{oi} = T_{outside} - T_{inside}$  (°F)

S2 and C2 represent the change (pre-post) in slope and intercept, respectively

**Table 3.5.1.** Sensible EER regressions

Site		Value	95% Confidence Interval		R <sup>2</sup>
#1 CheckMe!	S1	-0.06256	-0.06399	-0.06114	0.6731
	S2	<b>-0.00129</b>	-0.00479	0.00221	
	C1	6.14205	6.11384	6.17025	
	C2	<b>-0.16675</b>	-0.23141	-0.10208	
#1 Aeroseal	S1	-0.05955	-0.06078	-0.05832	0.8205
	S2	<b>-0.00301</b>	-0.00475	-0.00127	
	C1	6.59086	6.56470	6.61701	
	C2	<b>-0.44881</b>	-0.48454	-0.41309	
#1 Comprehensive Protocol	S1	-0.05955	-0.06126	-0.05784	0.6954
	S2	<b>-0.00430</b>	-0.00850	-0.00011	
	C1	6.59086	6.55449	6.62722	
	C2	<b>-0.61556</b>	-0.69426	-0.53686	
#6	S1	-0.05861	-0.06073	-0.05650	0.8365
	S2	<b>-0.02021</b>	-0.02250	-0.01793	
	C1	5.47476	5.45115	5.49836	
	C2	<b>0.03535</b>	0.00864	0.06206	

To minimize the effect of changing return temperature and humidity on sensible efficiency, data were filtered by the target temperature split as published by Carrier Corporation. The regressions include data falling within 1 °F of the mean target temperature split across the entire (pre and post-repair) monitoring period.

The pre-repair steady state data for site #1 was limited because the evaporator coil was icing up. The icing was caused by low refrigerant charge and occurred at low inside and outside temperatures. Prior to performing the regression, the pre-repair data was filtered to remove data from when the coil was iced. This was necessary to obtain a representative regression, but it limits the data to high  $\Delta T_{oi}$  values.

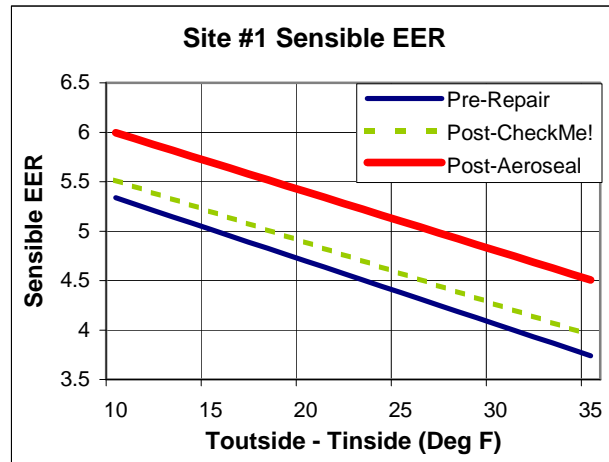

Figure 3.5.1 Site #1 Sensible EER

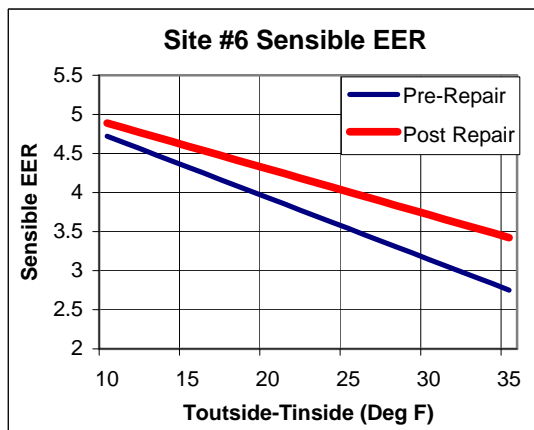

Figure 3.5.2. Site #6 Sensible EER

Pre- and post-repair sensible EERs are shown in Figures 3.5.1 and 3.5.2. Site #1 has results from the refrigerant adjustment alone as well as the combination refrigerant adjustment and duct sealing.

The comprehensive protocol improved efficiency at both sites. The rate of decrease in sensible EER with increasing  $\Delta T_{oi}$  was also improved at both sites. The efficiency improvement is greatest when it is hottest outside.

The percent improvement in sensible EER at each site is shown in Figure 3.5.3. The improvement is significant at both sites, 20% or more for high  $\Delta T_{oi}$  values. Note that this efficiency improvement captures the impact of refrigerant charge adjustment and return side sealing. The impact of supply side sealing is not captured in this sensible EER.

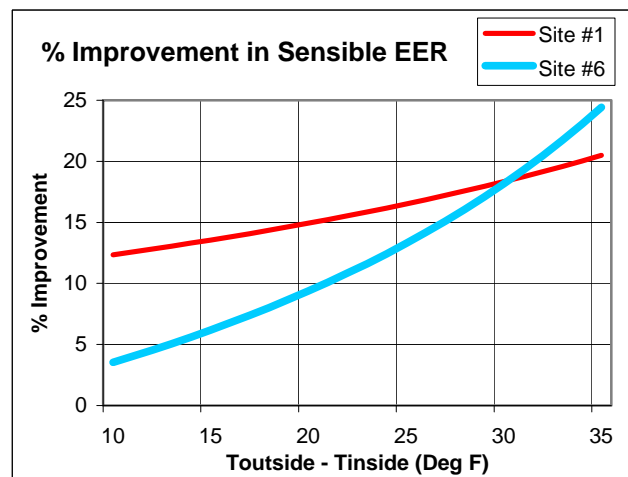

Figure 3.5.3. Sensible EER % Improvement

**Return Duct Heat Gain**

Pre and post-repair return duct heat gain was compared for sites #1, #2 and #6. The return duct temperature gain vs.  $\Delta T_{oi}$  linear regression results are tabulated below in the format:

$$\text{Post-repair return duct temperature gain (°F)} = S1 * \Delta T_{oi} + C1$$

$$\text{Pre-repair return duct temperature gain (°F)} = (S1+S2) * \Delta T_{oi} + (C1+C2)$$

Where  $\Delta T_{oi}$  = Toutside - Tinside (°F)

S2 and C2 represent the change (pre-post) in slope and intercept, respectively

**Table 3.5.2: Return Duct Temperature Gain Regressions**

Site		Value	95% Confidence Interval		R <sup>2</sup>
#1	S1	0.04072	0.03763	0.04380	0.7393
	S2	<b>0.03483</b>	0.03138	0.03828	
	C1	-1.48308	-1.54377	-1.42238	
	C2	<b>1.87523</b>	1.81038	1.94008	
#2	S1	0.00691	-0.01009	0.02390	0.5942
	S2	<b>0.03027</b>	0.01045	0.05009	
	C1	-1.54762	-1.80990	-1.28534	
	C2	<b>1.87194</b>	1.51520	2.22869	
#6	S1	0.05012	0.04569	0.05455	0.6362
	S2	<b>0.03323</b>	0.02845	0.03801	
	C1	0.82359	0.77421	0.87297	
	C2	<b>0.32023</b>	0.26438	0.37609	

Sealing reduced the temperature gain in the return duct at all 3 sites. Return sealing at site #1 was performed manually so the amount of sealing is estimated, not measured. It is estimated that the return sealing at site #1 was 2.2% of the measured fan flow. Return sealing at site #2 was measured at 7.4% of the fan flow (at 25 Pa). The amount of return sealing at site #6 is uncertain. The contractor that performed the sealing at this site did not provide data specific to supply and return. It is suspected that the majority of the sealing at this site was on the supply side.



The savings from return sealing are shown in figure 5.4.3, expressed as a percent of the system's sensible capacity. For this analysis the sensible capacity is taken to be the theoretical sensible capacity as predicted by the target temperature split published by Carrier Corporation.

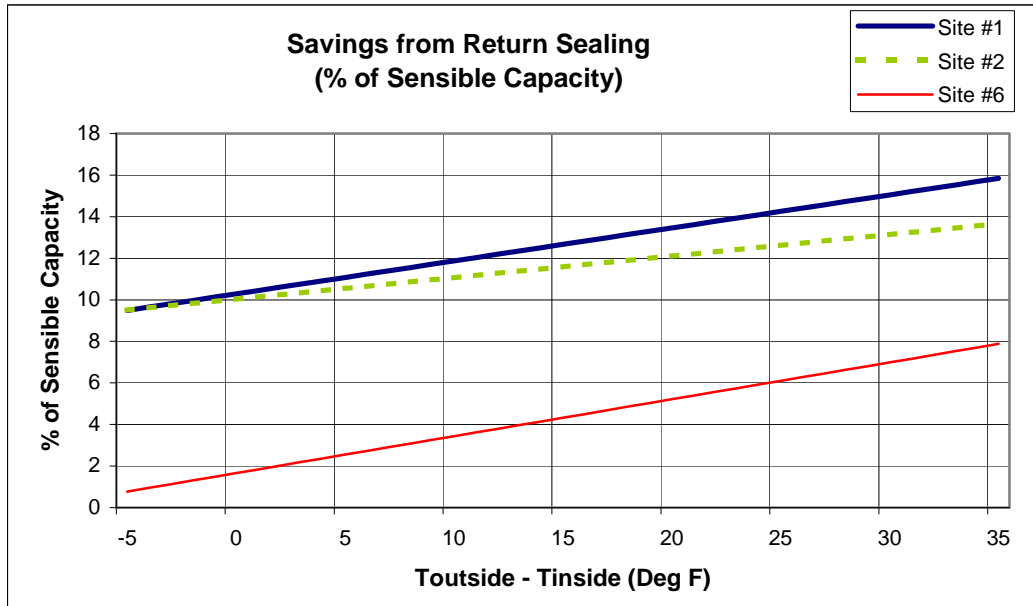

Figure 3.5.4. Savings Due to Return Sealing

All three sites demonstrate significant savings from return duct sealing, with the amount of savings increasing with increasing  $\Delta T_{oi}$ .

## IV. CONCLUSION

---

Light commercial facilities have great potential for energy savings opportunities due to their substantial deficiencies in cooling system performance. In particular, large improvements can be gained through interventions that include: evaporator coil airflow improvement, refrigerant charge adjustment, duct sealing, and economizer adjustment. This project addressed several issues involved in the development of a comprehensive light commercial diagnostics and improvement protocol. In particular, the following tasks were completed:

- Stand-alone HVAC data lookup software was created. The software accesses a comprehensive database of air conditioners and provides capacity, efficiency, and year of manufacture based on make and model.
- A diffuser sealing system was refined and integrated with the AeroSeal duct sealing protocol. The system is now applicable to light commercial duct systems.
- A new economizer diagnostic protocol was created. This protocol provides an appropriate level of diagnostics for widespread application by existing HVAC technicians.
- A cross-reference strategy was created for sharing data between AeroSeal and CheckMe!.
- An implementation protocol was generated. The protocol combines CheckMe! and AeroSeal analyses as well as combustion safety and economizer diagnosis.

The protocol developed in this project addresses the major detractors of the efficiency of HVAC systems in light commercial buildings. Through the application of this protocol, energy and comfort improvements can be achieved at reasonably low cost utilizing technicians specially trained in the technologies involved.

The steps of the protocol are:

- 1) Pre-sealing combustion safety check
- 2) AeroSeal diagnostic
- 3) AeroSeal duct sealing
- 4) Post-sealing combustion safety check
- 5) Economizer diagnostics and adjustment
- 6) CheckMe! diagnostic
- 7) CheckMe! repairs and follow-up diagnostic

---

## Conclusion

The study team paid careful attention to making the procedure time efficient and to keeping the tasks within the capabilities and skill sets of typical HVAC contractor personnel. Together, the protocols in this package are expected to achieve an 18% to 45% savings<sup>2</sup> of HVAC energy use.

Site monitoring was performed to measure the energy savings for particular cases. Data collected from six sites in the Sacramento, CA area in the fall of 2003 and summer of 2004 demonstrated anticipated savings with one exception. That exception was a unit that had a level two problem (restriction in the liquid line). The units with duct sealing showed savings that increased with increasing outside-inside temperature difference. The savings are largest under peak conditions. The following improvements were documented:

- Improved sensible EER: The improvement averaged 18.2%, at a 30°F outside-inside temperature differential.
- Reduced heat gain in the return duct: Duct sealing eliminated return side sensible heat gains equivalent to an average of 12.4% of the system's sensible capacity, at a 30°F outside-inside temperature differential.

These results provide evidence that the comprehensive protocol is effective in reducing light commercial HVAC energy use and peak demand.

---

<sup>2</sup> The highest level of savings will occur in units with economizers and/or significant duct leakage.

## REFERENCES

---

CB ECS 1995 "Commercial Buildings Energy Consumption and Expenditures, 1992" *Energy Information Administration U.S. Department of Energy DOE/EIA-0318(92)*

Cummings J. B., Withers C. R., Moyer N., Fairey P., McKendry B. 1996 "Uncontrolled Air Flow in Non-Residential Buildings" *Florida Solar Energy Center FSEC-CR-878-96*

W. W. Delp, N. Matson, D. J. Dickerhoff, D. Wang, R. C. Diamond, M. P. Modera "Field Investigation of Duct System Performance in California Light Commercial Buildings", *ASHRAE Trans. 104(II) 1998*, June 1998.

W. W. Delp, N. Matson, D. J. Dickerhoff, D. Wang, R. C. Diamond, M. P. Modera "Field Investigation of Duct System Performance in California Light Commercial Buildings (Round II)." *Proceedings of ACEEE Summer Study, Pacific Grove, CA, August 1998.*

EPRI, "Field Testing of Aerosol-Based Sealing Technology", Electric Power Research Institute Report, Palo Alto, California, EPRI TR-107981, 3841-04, June 1997.

Hewett et al., "Measured Energy and Demand Impacts of Efficiency Tune-ups for Small Commercial Cooling Systems" *ACEEE 1992 Summer Study on Energy Efficiency in Buildings*

P. Jacobs, Architectural Energy Corporation, "Small HVAC Problems and Potential Savings Reports" *Technical Report October 2003, California Energy Commission*

D.A. Jump, I.S. Walker and M.P. Modera, "Field Measurements of Efficiency and Duct Retrofit Effectiveness in Residential Forced-Air Distribution Systems." *Proceedings of ACEEE Summer Study, Pacific Grove, CA, August 1996, Lawrence Berkeley Laboratory Report, LBL-38537.*

M.P. Modera, D.J. Dickerhoff, O. Nilssen, H. Duquette, and J. Geyselaers, "Residential Field Testing of an Aerosol-Based Technology for Sealing Ductwork." *Proceedings of ACEEE Summer Study, Pacific Grove, CA, August 1996, Lawrence Berkeley Laboratory Report, LBL-38554.*

Modera, M. P. 1993. "Characterizing the Performance of Residential Air Distribution Systems." *Energy and Buildings*, 20(1):65-75. LBL-32532, Lawrence Berkeley Laboratory, Berkeley, California.

Modera, M. P., and D. A. Jump. 1995. "Field Measurements of the Interactions Between Heat Pumps and Duct Systems in Residential Buildings." In *Proceedings of ASME International Solar Energy Conference, March, 1995.* LBL-36047, Lawrence Berkeley Laboratory, Berkeley, California.

Neme, Proctor, and Nadel, "National Energy Savings Potential from Addressing Residential HVAC Installation Problems" *Report to EPA, VEIC Burlington, VT 1999*

Proctor Engineering Group, "1999 Program Quality Assurance Report", Sacramento Municipal Utility District, Sacramento, CA 2000

---

## *References*

Proctor, Downey, Conant, and Wright, "CheckMe!® Commercial and Residential AC Tune-Up Project - Innovative Peak Load Reduction Program - Final Report", November 6, 2003, California Energy Commission, Sacramento, CA 2003

Vick et al., "Evaluation of a 'Super Tune-up' Pilot Program for Forced-Air Furnaces in Small Commercial Buildings", 1991 International Energy Evaluation Conference

# **APPENDIX A: COMBUSTION SAFETY PROCEDURE FORMS**

---

PACKAGE UNIT FURNACE - COMMERCIAL

COMBUSTION APPLIANCE SAFETY TEST  
PROCEDURE

All Furnaces and Water Heaters **MUST** pass these tests before any duct sealing work is performed

Customer Name \_\_\_\_\_ Phone \_\_\_\_\_

Address \_\_\_\_\_ City \_\_\_\_\_ Zip Code \_\_\_\_\_

Pre-Test Tech \_\_\_\_\_ Date \_\_\_\_\_ Post-Test Tech \_\_\_\_\_ Date \_\_\_\_\_

**Pre-Test** (Pass) (Fail) (Emergency) (Follow - up) **Post-Test** (Pass) (Fail) (Emergency) (Follow - up)

FURNACE TEST

1. _____ Temp Out	Place thermometer outside in the shade and record outside temperature after it has stabilized. Zero your carbon monoxide meter.
2.	Cycle heating system from <u>thermostat</u> before starting to make sure it works. Relight pilot if necessary. If heating system does not turn on, STOP! Contact Supervisor and tell customer.
3.	Set thermostat down.
4. <b>Gas Leak</b> Yes No Location _____	Do you smell any gas leaks near the furnace? If gas leaks are detected record the location of all leaks found and inform customer of the repairs needed. Record all gas leaks as emergency situations. If there is a major gas leak <b>discontinue testing</b> .
5. <b>Carbon</b> Yes No	Is there is any carbon in the heat exchanger, draft hood, or gas vent?
6.	Use jumpers to run the furnace. Start your watch for a five-minute safety test when burners ignite.
7. <b>Flame Interference</b> Yes No	Do furnace flames burn differently with the fan operating? <b>If Yes, STOP!</b> Inform the customer that the furnace should have a cracked heat exchanger test performed. <b>Discontinue testing.</b> Ducts cannot be sealed until fixed.
8. C.O. _____ ppm	At five minutes, check the furnace with the gas burning:
9.	<b>CO content must be less than 100 ppm.</b> If C.O. exceeds 100 ppm, record all details necessary in comments and inform customer of the repairs needed. Record as an emergency situation. <b>Discontinue testing.</b> The ducts cannot be sealed until fixed.
10.	Remove the jumpers and set the fan switch to the ON position.

© 2003 Proctor Engineering Group  
418 Mission Avenue, San Rafael, CA 94901 (415) 451-2480  
Reproduction in unlimited quantities authorized. All reproductions must carry this notification.  
Revised October 3, 2009

## PACKAGE UNIT FURNACE - COMMERCIAL

### WATER HEATER TEST

11. _____	Record the location of the water heater.
12.	Drill hole in gas vent two feet above the draft hood, but not in an elbow.
13.	Turn on all fans that exhaust from the building. <b>Close all exterior windows and doors. Open all other interior doors.</b>
14. <b>Carbon</b> Yes No	Is there is any carbon in the center tube, draft hood, or gas vent?
15. <b>Gas Leak</b> Yes No Location _____	Do you smell any gas leaks near the water heater? If gas leaks are detected record the location of all leaks found and inform customer of the repairs needed. Record all gas leaks as emergency situations. If there is a major gas leak <b>discontinue testing.</b>
16.	<b>Mark the existing water temperature setting.</b> Raise the temperature setting or run water to keep burner on for five minutes. Start your watch for five minute test.
17.	Close door to water heater room. If the water heater is located within a confined space set up for remote testing.
18. <b>Defective Vent</b> Yes No	While waiting, is the flue or vent disconnected, rusted, or have any other defect that can leak combustion products into the building? If Yes, inform customer of the repairs needed, record as emergency and <b>discontinue testing.</b> Ducts cannot be sealed until fixed.
19. C.O. _____ ppm Draft _____ pa Spillage Yes No	At five minutes, check the water heater with the gas burning: <i>(See #22 for Acceptable Draft Standards vs. Outside Ambient Temperature)</i>
20. C.O. _____ ppm Draft _____ pa Spillage <b>Yes No</b>	Open the water heater room door and check water heater with the gas burning: <i>(See #22 for Acceptable Draft Standards vs. Outside Ambient Temperature)</i>
21.	<b>CO content must be less than 100 ppm.</b> If C.O. exceeds 100 ppm, record all details necessary in comments and inform customer of the repairs needed. Record as an emergency situation. The ducts cannot be sealed until fixed.
22. <b>ACCEPTABLE DRAFT IS:</b> Outside temp over 80°F -1 Pa or more negative Outside temp 30 to 80°F -2.5 Pa or more negative Outside temp below 30°F -5 Pa or more negative	If spillage is present, or draft is not acceptable, inform customer of the repairs needed. Ducts cannot be sealed until fixed.  <b>IF SPILLAGE IS PRESENT, OR COMBUSTION PRODUCTS ARE LEAKING FROM THE FLUE/VENT AND CO EXCEEDS 100 PPM, RECORD AS EMERGENCY, DISABLE THE APPLIANCE. INFORM CUSTOMER OF THE REPAIRS NEEDED.</b>

© 2003 Proctor Engineering Group  
418 Mission Avenue, San Rafael, CA 94901 (415) 451-2480  
Reproduction in unlimited quantities authorized. All reproductions must carry this notification.  
Revised October 3, 2009



## PACKAGE UNIT FURNACE - COMMERCIAL

23.	Return water heater thermostat to original setting and turn off all exhaust fans turned on in step 13. Set the furnace fan switch to AUTO.
-----	--

### FINAL TESTS

These tests are to be performed after ALL duct sealing work is completed

### FURNACE TEST

24.      _____ Temp Out	Place thermometer outside in the shade and record outside temperature after it has stabilized. While outdoors zero your carbon monoxide meter.
25. <b>Gas Leak</b> Yes    No Location _____	Do you smell any gas leaks near the furnace? If gas leaks are detected record the location of all leaks found and inform customer of the repairs needed. Record all gas leaks as emergency situations. If there is a major gas leak <b>discontinue testing</b> .
26.	Use jumpers to run the furnace. Start your watch for a five-minute safety test when burners ignite.
27. <b>Flame Interference</b> Yes    No	Do furnace flames burn differently with the fan operating? <b>If Yes, STOP!</b> Inform the customer that the furnace should have a cracked heat exchanger test performed. <b>Discontinue testing.</b> Ducts cannot be sealed until fixed.
28.      C.O. _____ ppm	At five minutes, check the furnace with the gas burning:
29.	<b>CO content must be less than 100 ppm.</b> If C.O. exceeds 100 ppm, record the heat exchanger shell(s) that have C.O. present and refer for repair. Record as an emergency situation. <b>The C.O. must be fixed by the program within 24 hours.</b>
30.	Remove the jumpers and set the fan switch to ON.

### WATER HEATER TEST

31.	Turn on all fans that exhaust from the building. <b>Close all exterior windows and doors. Open all other interior doors.</b>
32.	Raise the temperature setting or run water to keep burner on for five minutes. Start your watch for five minute test.
33.	Close door to water heater room. If the water heater is located within a confined space set up for remote testing equipment.
34.      C.O. _____ ppm Draft _____ pa Spillage Yes    No	At five minutes, check the water heater with the gas burning:

© 2003 Proctor Engineering Group  
418 Mission Avenue, San Rafael, CA 94901 (415) 451-2480  
Reproduction in unlimited quantities authorized. All reproductions must carry this notification.  
Revised October 3, 2009

**PACKAGE UNIT FURNACE - COMMERCIAL**

35. C.O. _____ ppm Draft _____ pa Spillage <b>Yes No</b>	Open the water heater room door and check water heater with the gas burning:
36.	<b>CO content must be less than 100 ppm.</b> If C.O. exceeds 100 ppm, record that water heater has C.O. present and refer for repair. Record as an emergency situation.
37. <b><u>ACCEPTABLE DRAFT IS:</u></b> Outside temp over 80°F -1 Pa or more negative Outside temp 30 to 80°F -2.5 Pa or more negative Outside temp below 30°F -5 Pa or more negative	If spillage is present, or draft is not acceptable, <b>the problem must be fixed.</b> Record as Emergency.  <b>IF SPILLAGE IS PRESENT, OR COMBUSTION PRODUCTS ARE LEAKING FROM THE FLUE/VENT <u>AND</u> CO EXCEEDS 100 PPM, RECORD AS EMERGENCY, DISABLE THE APPLIANCE. INFORM THE CUSTOMER AND CONTACT SUPERVISOR.</b>
38.	Return water heater thermostat to original setting and turn off all exhaust fans turned on in step 31. Turn the furnace fan to AUTO.

**COMMENTS**

---

---

---

---

---

---

---

---

---

---

---

---

---

---

---

---

---

---

---

---

---

---

---

---

---

---

© 2003 Proctor Engineering Group  
 418 Mission Avenue, San Rafael, CA 94901 (415) 451-2480  
 Reproduction in unlimited quantities authorized. All reproductions must carry this notification.  
 Revised October 3, 2009

SPLIT SYSTEM FURNACE - COMMERCIAL

**COMBUSTION APPLIANCE SAFETY TEST**  
**PROCEDURE**

All Furnaces and Water Heaters **MUST** pass these tests before any duct sealing work is performed

Customer Name \_\_\_\_\_ Phone \_\_\_\_\_

Address \_\_\_\_\_ City \_\_\_\_\_ Zip Code \_\_\_\_\_

Pre-Test Tech \_\_\_\_\_ Date \_\_\_\_\_ Post-Test Tech \_\_\_\_\_ Date \_\_\_\_\_

**Pre-Test** (Pass) (Fail) (Emergency) (Follow - up) **Post-Test** (Pass) (Fail) (Emergency) (Follow - up)

**FURNACE TEST**

1. _____ Temp Out	Place thermometer outside in the shade and record outside temperature after it has stabilized. While outdoors zero your carbon monoxide meter.
2.	Cycle heating system from <u>thermostat</u> before starting to make sure it works. Relight pilot if necessary. If heating system does not turn on, STOP! Contact Supervisor and tell customer.
3.	Set thermostat down.
4. <b>Gas Leak</b> Yes No Location _____	Do you smell any gas leaks near the furnace? If gas leaks are detected record the location of all leaks found and inform customer of the repairs needed. Record all gas leaks as emergency situations. If there is a major gas leak <b>discontinue testing</b> .
5.	Turn on all fans that exhaust from the building. <b>Close all exterior windows and doors. Open all other interior doors.</b>
6. <b>Carbon</b> Yes No	Is there is any carbon in the heat exchanger, draft hood, or gas vent?
7.	Use jumpers to run the furnace. Start your watch for five minute safety test when burners ignite.
8. <b>White Flames</b> Yes No <b>Roll out</b> Yes No	Check how flames are burning. Do you notice any yellow/white in the flames? If yes, record in comments. Any Roll out? If yes, record in comments. If roll out is severe inform customer of the repairs needed, record as emergency and <b>discontinue testing</b> . Ducts cannot be sealed until fixed.

© 2003 Proctor Engineering Group  
418 Mission Avenue, San Rafael, CA 94901 (415) 451-2480  
Reproduction in unlimited quantities authorized. All reproductions must carry this notification.  
Revised October 3, 2009

## SPLIT SYSTEM FURNACE - COMMERCIAL

9.	<b>Flame Interference</b> Yes No	Do furnace flames burn differently with the fan operating? <b>If Yes, STOP!</b> Inform the customer that the furnace should have a cracked heat exchanger test performed. <b>Discontinue testing.</b> Ducts cannot be sealed until fixed.
10.	C.O. _____ ppm Draft _____ pa Spillage Yes No	At five minutes, check the furnace with the gas burning:  (See #12 for Acceptable Draft Standards vs. Outside Ambient Temperature)
11.		<b>CO content must be less than 100 ppm.</b> If C.O. exceeds 100 ppm, record all details necessary in comments and inform customer of the repairs needed. Record as an emergency situation. <b>Discontinue testing.</b> The ducts cannot be sealed until fixed.
12.	<b>ACCEPTABLE DRAFT IS:</b> Outside temp over 80°F -1 Pa or more negative Outside temp 30 to 80°F -2.5 Pa or more negative Outside temp below 30°F -5 Pa or more negative	If spillage is present, or draft is not acceptable, inform customer of the repairs needed. Ducts cannot be sealed until fixed.  <b>IF SPILLAGE IS PRESENT, OR COMBUSTION PRODUCTS ARE LEAKING FROM THE FLUE/VENT AND CO EXCEEDS 100 PPM, RECORD AS EMERGENCY, DISABLE THE APPLIANCE. INFORM CUSTOMER OF THE REPAIRS NEEDED.</b>
13.		Remove jumpers and set the fan switch to the <b>ON</b> position. (Fan needs to be running for Water Heater Test)

### WATER HEATER TEST

14.	_____	Record the location of the water heater.
15.		Drill hole in gas vent two feet above the draft hood, but not in an elbow.
16.		Turn on all fans that exhaust from the building. <b>Close all exterior windows and doors. Open all other interior doors.</b>
17.	<b>Carbon</b> Yes No	Is there is any carbon in the center tube, draft hood, or gas vent?
18.	<b>Gas Leak</b> Yes No Location _____	Do you smell any gas leaks near the water heater? If gas leaks are detected record the location of all leaks found and inform customer of the repairs needed. Record all gas leaks as emergency situations. If there is a major gas leak <b>discontinue testing.</b>
19.		<b>Mark the existing water temperature setting.</b> Raise the temperature setting or run water to keep burner on for five minutes. Start your watch for five minute test.
20.		Close door to water heater room. If the water heater is located within a confined space set up for remote testing equipment.
21.	<b>Defective Vent</b> Yes No	While waiting, is the flue or vent disconnected, rusted, or have any other defect that can leak combustion products into the building? If Yes, inform customer of the repairs needed, record as emergency and <b>discontinue testing.</b> Ducts cannot be sealed until fixed.

© 2003 Proctor Engineering Group  
418 Mission Avenue, San Rafael, CA 94901 (415) 451-2480  
Reproduction in unlimited quantities authorized. All reproductions must carry this notification.  
Revised October 3, 2009

## SPLIT SYSTEM FURNACE - COMMERCIAL

22.	C.O. _____ ppm Draft _____ pa Spillage Yes No	At five minutes, check the water heater with the gas burning: (See #25 for Acceptable Draft Standards vs. Outside Ambient Temperature)
23.	C.O. _____ ppm Draft _____ pa Spillage Yes No	Open the water heater room door and check water heater with the gas burning: (See #25 for Acceptable Draft Standards vs. Outside Ambient Temperature)
24.		<b>CO content must be less than 100 ppm.</b> If C.O. exceeds 100 ppm, record all details necessary in comments and inform customer of the repairs needed. Record as an emergency situation. The ducts cannot be sealed until fixed.
25.	<b><u>ACCEPTABLE DRAFT IS:</u></b> Outside temp over 80°F -1 Pa or more negative Outside temp 30 to 80°F -2.5 Pa or more negative Outside temp below 30°F -5 Pa or more negative	If spillage is present, or draft is not acceptable, inform customer of the repairs needed. Ducts cannot be sealed until fixed.  <b>IF SPILLAGE IS PRESENT, OR COMBUSTION PRODUCTS ARE LEAKING FROM THE FLUE/VENT <u>AND</u> CO EXCEEDS 100 PPM, RECORD AS EMERGENCY, DISABLE THE APPLIANCE. INFORM CUSTOMER OF THE REPAIRS NEEDED.</b>
26.		Return water heater thermostat to original setting and turn off all exhaust fans turned on in step 16. Set the furnace fan switch to AUTO.

### FINAL TESTS

These tests are to be performed after ALL duct sealing work is completed

### FURNACE TEST

27.	_____ Temp Out	Place thermometer outside in the shade and record outside temperature after it has stabilized. While outdoors zero your carbon monoxide meter.
28.	<b>Gas Leak</b> Yes No Location _____	Do you smell any gas leaks near the furnace? If gas leaks are detected record the location of all leaks found and inform customer of the repairs needed. Record all gas leaks as emergency situations. If there is a major gas leak <b>discontinue testing.</b>
29.		Turn on all fans that exhaust from the building. <b>Close all exterior windows and doors. Open all other interior doors.</b>
30.		Use jumpers to run furnace. Start your watch for five minute safety test when burners ignite.

## SPLIT SYSTEM FURNACE - COMMERCIAL

<p>31. <b>White Flames</b> Yes No <b>Roll out</b> Yes No</p>	<p>Check how flames are burning. Do you notice any yellow/white in the flames? If yes, record in comments. Any Roll out? If yes, <i>record in comments</i> at end of this form. If roll out is severe inform customer of the repairs needed, record as emergency and <b>discontinue testing</b>. Ducts cannot be sealed until fixed.</p>
<p>32. <b>Flame Interference</b> Yes No</p>	<p>Do furnace flames burn differently with the fan operating? <b>If Yes, STOP!</b> Inform the customer that the furnace should have a cracked heat exchanger test performed. <b>Discontinue testing</b>. Ducts cannot be sealed until fixed.</p>
<p>33. C.O. _____ ppm Draft _____ pa Spillage Yes No</p>	<p>At five minutes, check the furnace with the gas burning:  (See #35 for Acceptable Draft Standards vs. Outside Ambient Temperature)</p>
<p>34.</p>	<p><b>CO content must be less than 100 ppm.</b> If C.O. exceeds 100 ppm, record the heat exchanger shell(s) that have C.O. present and refer for repair. Record as an emergency situation. <b>The C.O. must be fixed by the program within 24 hours.</b></p>
<p>35. <b>ACCEPTABLE DRAFT IS:</b> Outside temp over 80°F -1 Pa or more negative Outside temp 30 to 80°F -2.5 Pa or more negative Outside temp below 30°F -5 Pa or more negative</p>	<p>If spillage is present, or draft is not acceptable, inform customer of the repairs needed. Ducts cannot be sealed until fixed.  <b>IF SPILLAGE IS PRESENT, OR COMBUSTION PRODUCTS ARE LEAKING FROM THE FLUE/VENT AND CO EXCEEDS 100 PPM, RECORD AS EMERGENCY, DISABLE THE APPLIANCE. INFORM CUSTOMER OF THE REPAIRS NEEDED.</b></p>
<p>36.</p>	<p>Remove jumpers and set the fan switch to ON.</p>

### WATER HEATER TEST

<p>37.</p>	<p>Turn on all fans that exhaust from the building. <b>Close all exterior windows and doors. Open all other interior doors.</b></p>
<p>38.</p>	<p>Raise the temperature setting or run water to keep burner on for five minutes. Start your watch for five minute test.</p>
<p>39.</p>	<p>Close door to water heater room. If the water heater is located within a confined space set up for remote testing equipment.</p>
<p>40. C.O. _____ ppm Draft _____ pa Spillage Yes No</p>	<p>At five minutes, check the water heater with the gas burning:</p>
<p>41. C.O. _____ ppm Draft _____ pa Spillage Yes No</p>	<p>Open the water heater room door and check water heater with the gas burning:</p>

© 2003 Proctor Engineering Group  
418 Mission Avenue, San Rafael, CA 94901 (415) 451-2480  
Reproduction in unlimited quantities authorized. All reproductions must carry this notification.  
Revised October 3, 2009

---

**SPLIT SYSTEM FURNACE - COMMERCIAL**

42.	<b>CO content must be less than 100 ppm.</b> If C.O. exceeds 100 ppm, record that water heater has C.O. present and refer for repair. Record as an emergency situation. <b>The C.O. must be fixed by the program within 24 hours.</b>
43. <b><u>ACCEPTABLE DRAFT IS:</u></b> Outside temp over 80°F -1 Pa or more negative Outside temp 30 to 80°F -2.5 Pa or more negative Outside temp below 30°F -5 Pa or more negative	If spillage is present, or draft is not acceptable, <b>the problem must be fixed.</b> Record as Emergency.  <b>IF SPILLAGE IS PRESENT, OR COMBUSTION PRODUCTS ARE LEAKING FROM THE FLUE/VENT <u>AND</u> CO EXCEEDS 100 PPM, RECORD AS EMERGENCY, DISABLE THE APPLIANCE. INFORM THE CUSTOMER AND CONTACT SUPERVISOR.</b>
44.	Return water heater thermostat to original setting and turn off all exhaust fans turned on in step 37. Turn the furnace fan to AUTO.

**COMMENTS**

---

---

---

---

---

---

---

---

## **APPENDIX B: AEROSEAL PROTOCOLS FOR LIGHT-COMMERCIAL DUCT LEAKAGE DIAGNOSIS AND SEALING**

---

The AeroSeal diagnosis and sealing methodology for light commercial buildings is best illustrated by photographs of diffusers and sealing techniques that differ from those found and used in residences.



**Figure B.1:** Clamp on a hinged perforated-plate diffuser. Technicians should always look for clamps and hinges, as the use of foam plugs is always preferable to other diffuser sealing techniques for aerosol injection.





**Figure B.2:** Recessed internal vanes within a hinged diffuser. When such vanes are not recessed, they can often be removed temporarily.



**Figure B.3:** Foam plug applied to the central discharge, below the recessed vanes of a hinged diffuser.



**Figure B.4:** Plastic film tape installed prior to application of a magnetic sheet to a ferrous perforated-plate diffuser.

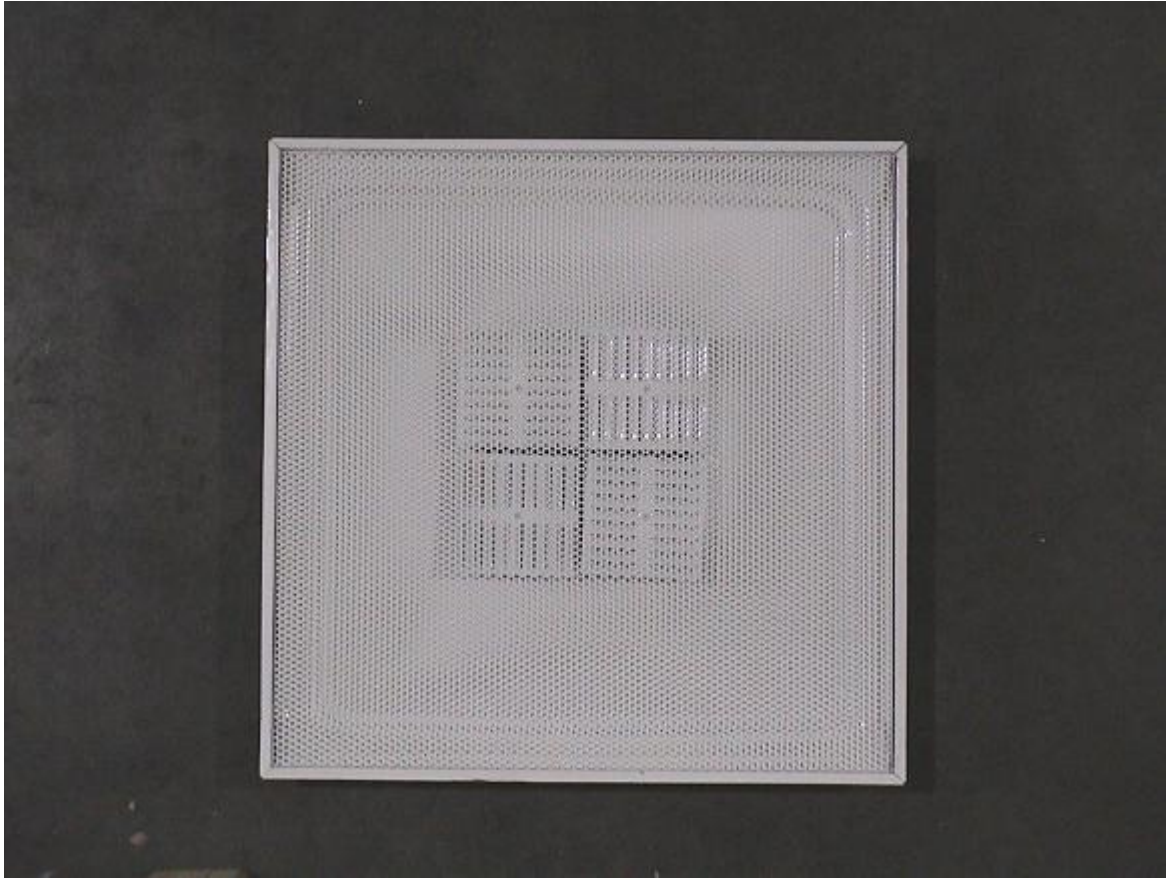

**Figure B.5:** Four-way perforated plate diffuser. (courtesy of Lawrence Berkeley National Laboratory)



**Figure B.6:** Single gap diffuser that could be sealed with foam or tape, but not a magnet. (courtesy of Lawrence Berkeley National Laboratory)

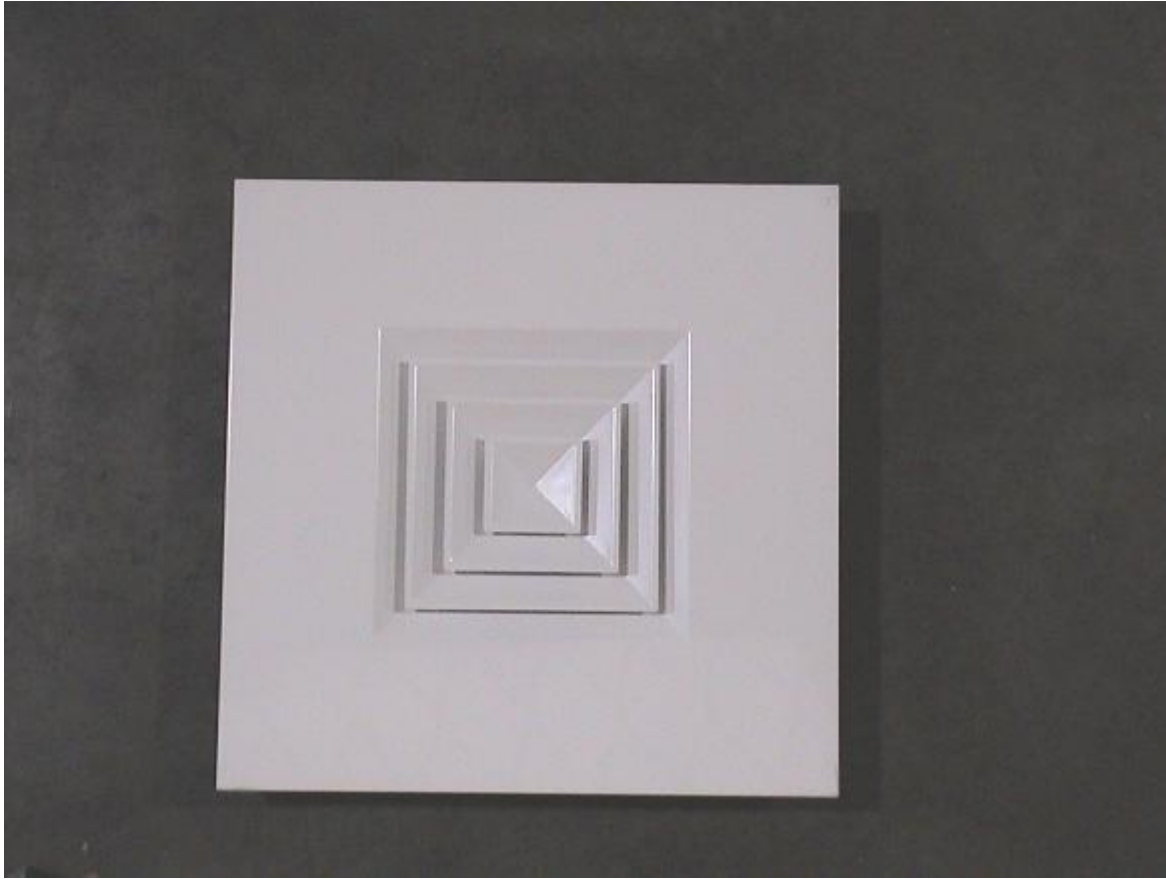

**Figure B.7:** Small area diffuser that can be temporarily sealed easily with a magnetic sheet (courtesy of Lawrence Berkeley National Laboratory)



**Figure B.8:** Fin diffuser, many of which can be sealed temporarily by removing fins and plugging opening with foam. (courtesy of Lawrence Berkeley National Laboratory)

---

## **APPENDIX C: ECONOMIZER DIAGNOSTICS FORM**

---



### ECONOMIZER DATA ENTRY FORM

**Section 1: Identification**

Date: \_\_\_\_\_

Model #: \_\_\_\_\_

Tech ID: \_\_\_\_\_

Number of sensors: \_\_\_\_\_ Setpoint: A B C D

Customer ID: \_\_\_\_\_

Minimum airflow setting: \_\_\_\_\_

Mechanical failure? Yes          No

Controller Manufacturer (circle):

Honeywell    Johnson Controls  
Trane          Other \_\_\_\_\_

Notes \_\_\_\_\_

**Section 2: Operation**

- A. Check range of motion by adjusting minimum air. Record static pressures and area estimates.
- B. Test in heating mode.
- C. Switch to cooling mode, cool sensor with ice, note temps and compressor operation on warmup.

Minimum Air: Econ/Total Area \_\_\_\_\_

Fully Open: Econ/Total Area \_\_\_\_\_

Mixed Static Pressure \_\_\_\_\_

Mixed Static Pressure \_\_\_\_\_

Return Static Pressure \_\_\_\_\_

Return Static Pressure \_\_\_\_\_

	<i>Economizer Position</i> <i>(check min/max or estimate percentage open for Other)</i>			<i>Temperatures</i> <i>(or mA output for Honeywell— note sensor model)</i>		<i>Compressor On?</i>
	Min	Max	Other	Outdoor sensor	Return sensor (if applicable)	
<b>1) Furnace on</b>						
<b>2) AC — sensor cooled w/ ice</b>						
<b>3) AC — 1<sup>st</sup> crossover</b>						
<b>4) AC — 2<sup>nd</sup> crossover (if any)</b>						

**Section 3: Results and Adjustment**

% Outdoor Air (minimum position): \_\_\_\_\_

Final Minimum Air Setting: \_\_\_\_\_

% Outdoor Air (fully open position): \_\_\_\_\_

Final Crossover Setting: \_\_\_\_\_

---

*Economizer Diagnostics Form*

Notes: \_\_\_\_\_

\_\_\_\_\_

\_\_\_\_\_

\_\_\_\_\_

## **APPENDIX D: AIR CONDITIONER TESTING FORM**

---



## 2003 CheckMe!® Air Conditioner Data Entry Form

CALL 1-(877)-243-2563 Toll Free for Data Entry or Technical Help

*Se habla Español*

**Customer ID#** \_\_\_\_\_ **Zip** \_\_\_\_\_

**Program:** ▪ CEC ▪ CPUC ▪ Other \_\_\_\_\_  
**New Unit:**  Yes  No **Title 24:**  Yes  No

**CPUC Customer Information:**

- Utility Acct. # \_\_\_\_\_  Not Avail.
- Tenant status:  Owner  Renter/Lessee
- Customer has signed log or form (Re: access, double dipping, no extra charges):  Yes  No
- Language preference:  English  Spanish  Other
- Mobile Home:  Yes  No

**Commercial Jobs:**  
 # of employees at location \_\_\_\_\_

**Contractor:** \_\_\_\_\_ **Tech ID:** \_\_\_\_\_

**AC Information:**  
 Apt/Space/Suite # \_\_\_\_\_ AC# \_\_\_\_\_  
 Dog Data  Compressor # \_\_\_\_\_  
 Initial Test  Too Low to Test  Test After Repair

**Customer Information:**  
 First & Last Name or Company \_\_\_\_\_  
 Attn: \_\_\_\_\_

**Property Location:**  
 Address \_\_\_\_\_  
 City \_\_\_\_\_ State \_\_\_\_\_ Zip \_\_\_\_\_  
 Phone (\_\_\_\_\_) \_\_\_\_\_ - \_\_\_\_\_

**Mail-To (if different):**  
 First & Last Name or Company \_\_\_\_\_  
 Attn: \_\_\_\_\_  
 Address \_\_\_\_\_  
 City \_\_\_\_\_ State \_\_\_\_\_ Zip \_\_\_\_\_  
 Phone (\_\_\_\_\_) \_\_\_\_\_ - \_\_\_\_\_

**Outdoor Unit Info:** Make \_\_\_\_\_  
 Model # \_\_\_\_\_  Not Legible  
 Capacity (nominal btuh) \_\_\_\_\_  
 Year Manufactured: \_\_\_\_\_  Not Legible  
 AC Type:  Split  Package

**Dog Data (measured values from existing unit):**  
 Amps \_\_\_\_\_ Volts \_\_\_\_\_ Phase \_\_\_\_\_

**Title 24 Information:**  
 Serial Number \_\_\_\_\_  
 Calibration Dates: Gauge \_\_\_\_\_ Thermometer \_\_\_\_\_

**Test Information:**  
 Minutes AC running: Before Initial Test \_\_\_\_\_  
 Since Repairs Made \_\_\_\_\_  
 Refrigerant Type:  R-22  R-410a  
 TrueFlow Meter:  Yes – See TrueFlow form  No  
 Metering  Non-TXV (superheat)  
 Device Type:  TXV/Lennox Non-TXV (sub-cooling)  
 Lennox TXV (approach)  
 Target Sub-cooling/Approach \_\_\_\_\_

	Initial Test	Test After Repairs
Condenser Air Entering Temp		
Return Air Wet Bulb Temp		
Return Air Dry Bulb Temp		
Supply Air Dry Bulb Temp		
Suction Line Temp		
Evaporator Saturation Temp		
Condenser Saturation Temp		
Liquid Line Temp		
Suction (low side) Pressure		
Discharge (high side) Pressure		

### INITIAL TEST / TEST AFTER REPAIR RESULTS

**Refrigerant Charge:** (circle result) ▪ Undercharge / Undercharge ▪ Correct / Correct ▪ Overcharge / Overcharge  
**Actual Superheat / Subcooling/Approach** \_\_\_\_\_ / \_\_\_\_\_ **Target Superheat / Subcooling/Approach** \_\_\_\_\_ / \_\_\_\_\_  
**Airflow:** (circle result) ▪ Low Airflow / Low Airflow ▪ Correct Airflow / Correct Airflow ▪ Low Temp Drop / Low Temp Drop  
**Actual Temperature Drop** \_\_\_\_\_ / \_\_\_\_\_ **Target Temperature Drop** \_\_\_\_\_ / \_\_\_\_\_

#### IF A REPAIR WAS MADE:

**Factory Stamped Refrigerant Charge:** Pounds \_\_\_\_\_ Ounces \_\_\_\_\_  Not Legible  
**Refrigerant Charge Adjustment:** Actual Ounces Added \_\_\_\_\_ Actual Ounces Removed \_\_\_\_\_  
**Airflow Correction:** (check all applicable)  Opened Registers  Cleaned/Replaced Filter  Changed Blower Speed  
 Cleaned Blower  Cleaned Evaporator Coil  Modified Ducts

©2002 Proctor Engineering Group, Rev 10/28/02

# **APPENDIX E: HVAC LOOKUP INSTALLATION MANUAL**

---

# HVAC LOOKUP

## INSTALLATION AND SETUP

---

*HVAC Lookup* is database and tool for quickly looking up HVAC unit information. This document will describe machine how to install *HVAC Lookup*. It also contains information about using the MS Access Runtime on systems that do not have MS Access 2000 installed.

### ***Installation***

In order to use *HVAC Lookup*, it is necessary to run the installer. The installer not only copies "HVACLookup.mdb" to the target machines, it also copies a dependency DLL and adds the Programs menu to launch *HVAC Lookup*.

### **System Requirements**

*HVAC Lookup* will run on a "modern" Windows system. For decent performance, we recommend:

- A 500 MHz or better processor
- 128 MB of more RAM
- Setting the screen area resolution to at least "1024 x 768" ("800 x 600" is possible, but users will have to scroll often.)

### **Do you need the Microsoft Access 2000 Runtime?**

In many cases, no. If the target machine already has Microsoft Access 2000 or greater, you do not need to install the Microsoft Access 2000 Runtime. In fact, we strongly recommend against it in this case.

We recommend installing *HVAC Lookup* on a system that has Microsoft Access 2000, if possible, since it will allow for the full use of Microsoft Access 2000 features. However, for convenience, *HVAC Lookup* includes an optional Microsoft Access 2000 Runtime installer for machines without Microsoft Access 2000. This would include machines that only have Microsoft Access 97.

The installer will ask if it should install the **free Microsoft Access 2000 Runtime** at the end of an installation. This is only necessary for systems that do not already have Microsoft Access 2000 (or above) installed.

The Microsoft Access 2000 Runtime can be **installed, repaired or uninstalled** any time by launching "SETUP.EXE" in the "[CD Drive]\AccessRT" directory on the *HVAC Lookup* installation CD (where "[CD Drive]" equals the letter drive of you CD; for instance "D").

### ***Running the Installer***

1. To **launch the installer**, double-click the "Setup.exe" file on the CD. The full path will be "[CD Drive]:\Setup.exe" where "[CD Drive]" is the letter of you CD drive; for instance, "D". You will see a splash screen like this:



2. **Click Next.**

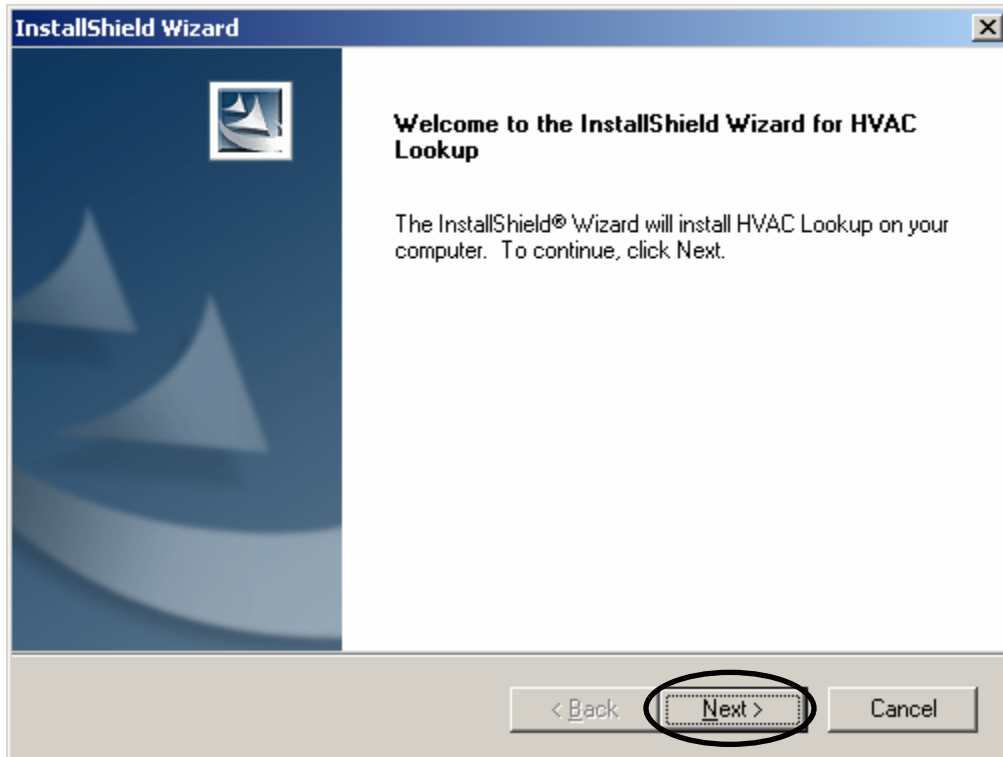

3. HVAC Lookup will install. Click **Finish**.

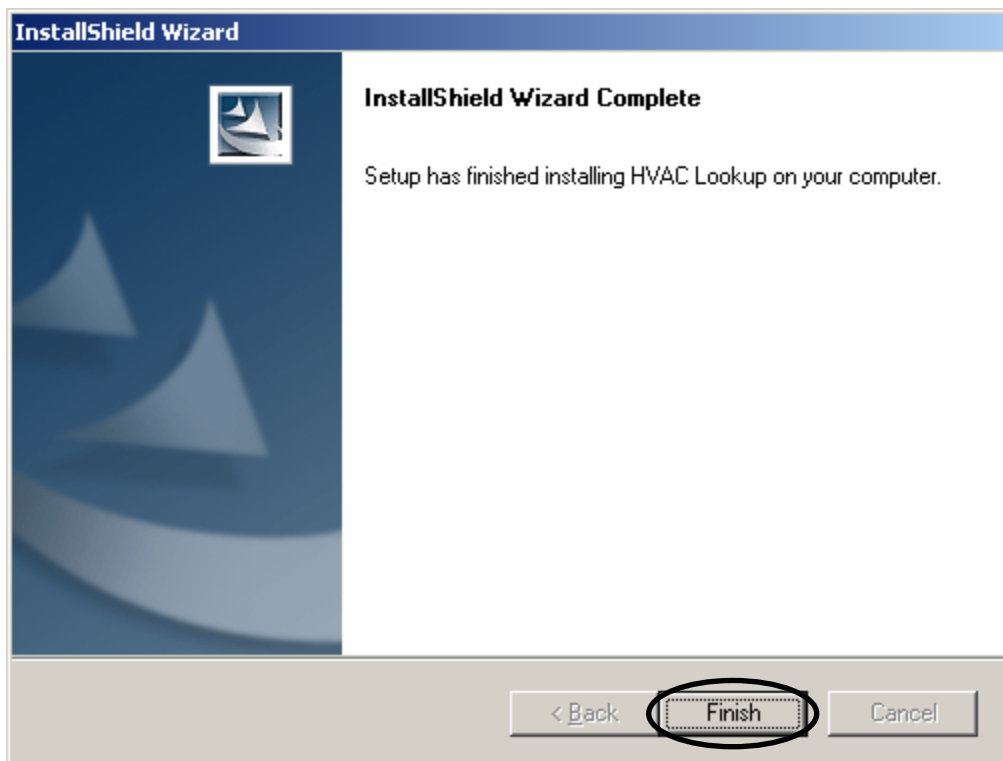



4. Next, the installer will ask if you need the Microsoft Access 2000 Runtime.

**Click “No” if you already have Microsoft Access 2000.** See the section “Do you need the Microsoft Access Runtime?” section above if Microsoft Access 2000 is not already on the target machine. If you need the Runtime, click “Yes”.

Clicking “No” will successfully end the installation. *HVAC Lookup* is ready to use.

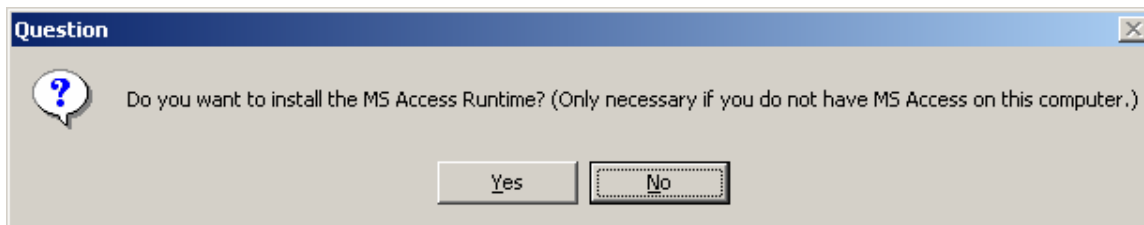

#### **Microsoft Access 2000 Runtime**

If you choose to install the Microsoft Access 2000 Runtime, click “Install Now”.

NOTE: this is only needed if your target machines does not already have Microsoft Access 2000.

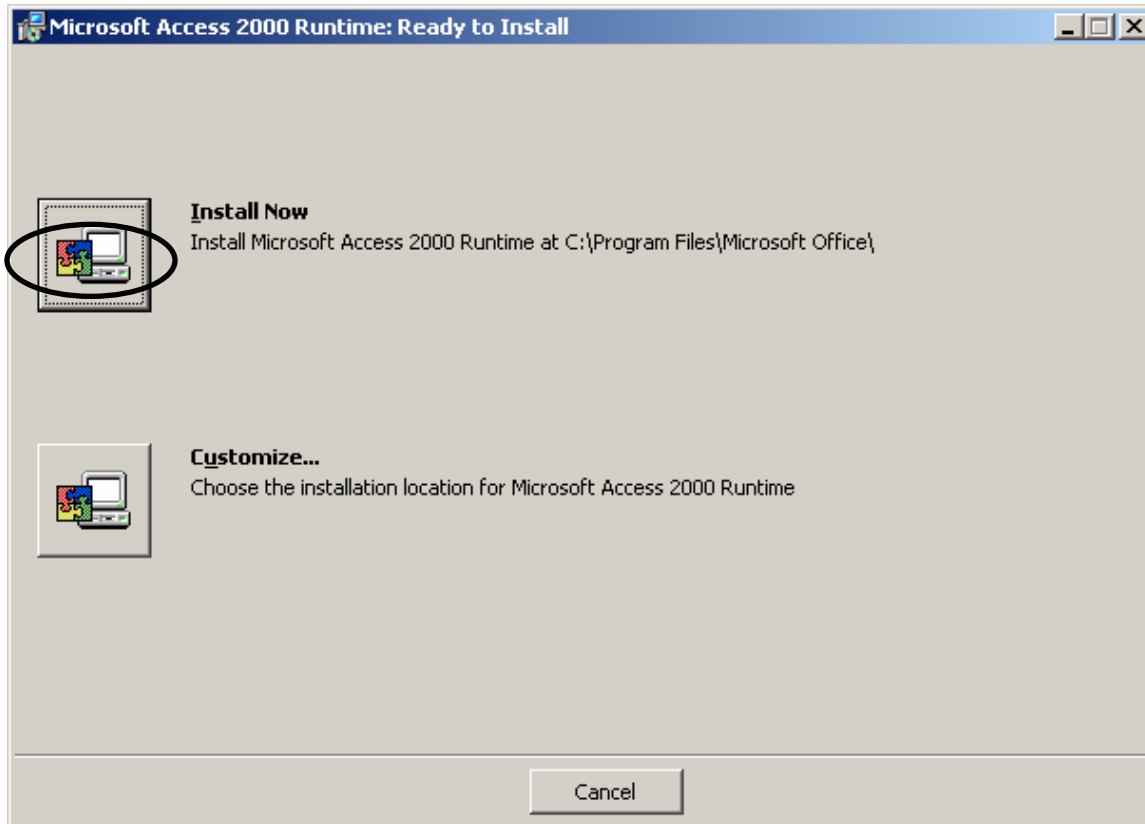

The installer will finish with the following message. Click OK to finish.



---

# **APPENDIX F: HVAC LOOKUP USER GUIDE**

---

# HVAC LOOKUP

## USER GUIDE

---

### **Description**

*HVAC Lookup* is database and tool for quickly looking up HVAC unit information. This document will describe how to use *HVAC Lookup* to quickly find correct model numbers and other information even in cases where the exact model number is unknown.

For example, given a **model number** like “38ARS01211”, *HVAC Lookup* shows a model’s:

- **Manufacturer** (example: “Carrier”)
- **Category** (example: “AC”)
- **Type** (example: “RCU-A-CB”)
- **Year** (example: “2002”)
- **Capacity** (example: “114000”)
- **Rating** (example: “10.3”)

In the real world, exact model numbers are often not available. They may be hidden, obscured, written down incorrectly or simply unknown. *HVAC Lookup* is designed to help a user rapidly browse from a ranked list of likely models to find the correct information.

### **Data Sources - What’s In the Database?**

*HVAC Lookup* contains 353,215 records for 303 manufacturers during the years 1967 to 2002. *HVAC Lookup* is based on two sources:

- 1) Carrier Blue Book CD (1967-1998)
- 2) California Energy Commission "Database of Energy Efficient Appliances"  
<http://www.energy.ca.gov/efficiency/appliances/> (10-Sep-2002)

All duplicate records have been removed. Also, substantial data cleansing was performed since both of the sources contain errors and inconsistent data formats. Literally, tens of thousands of records required cleansing.

Therefore, *HVAC Lookup* itself is a unique and valuable data source that exceeds the sum of its parts.

Also, *HVAC Lookup* is updateable. As new data is available, Aeroseal and Proctor Engineering can perform data cleansing and add to the database.

### ***Getting Started***

To open *HVAC Lookup*, in Windows click Start, Programs, HVAC Lookup, HVACLookup.mdb (as shown below).

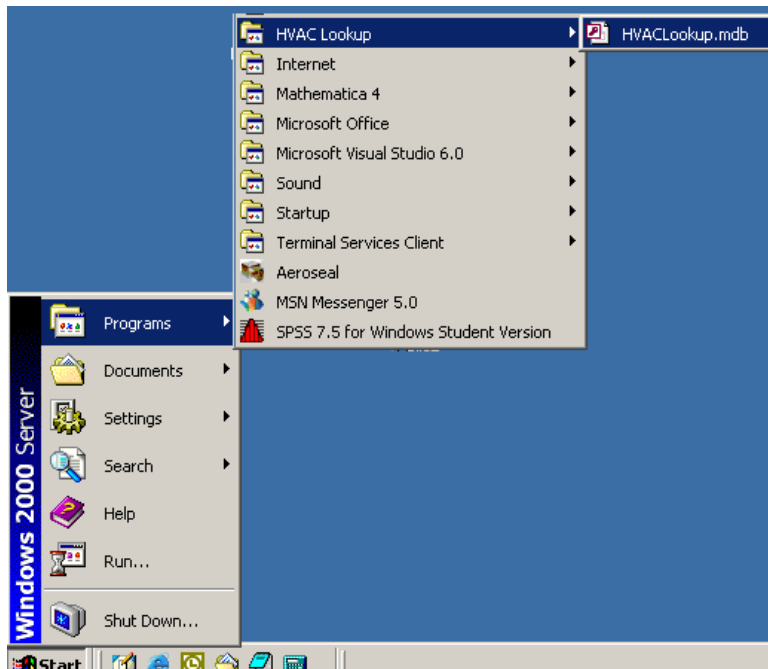

HVAC Lookup will launch. Your screen will look similar to this:

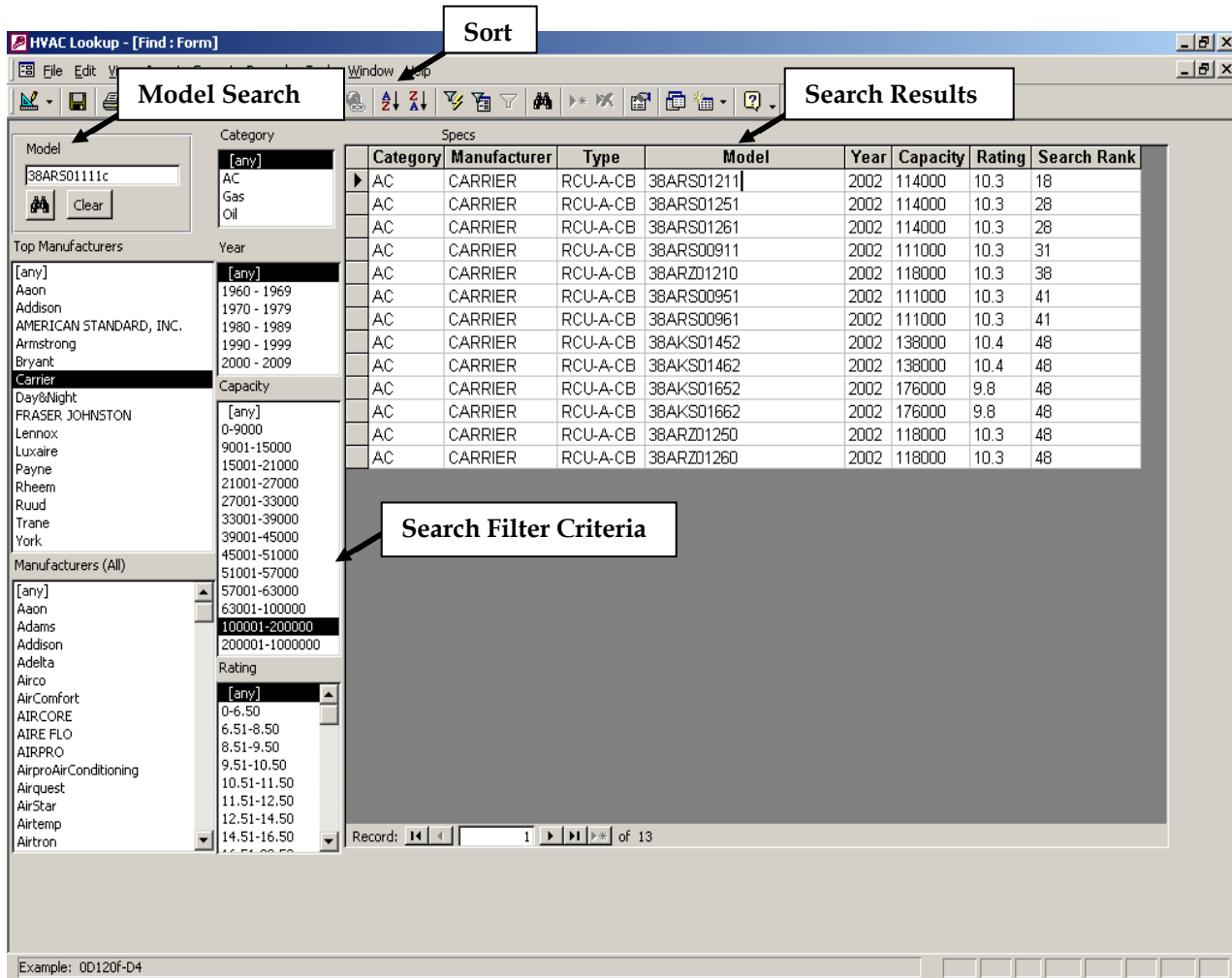

### How to Search

Searching in HVAC Lookup is designed to be intuitive. The examples below will help you get started. Users can slice and dice HVAC Lookup data using:

- Filters
- Pattern Matching and Ranking
- Both: Filters Combined with Pattern Matching and Ranking

In addition, HVAC Lookup supports **sorting** and the use of **wildcards** to search.

**Filters**

Filters limit the view of the database so that only records that satisfy the filter criteria are displayed. **To select a filter, click on a list box.** Clicking “[any]” means there is no filter.

To clear all filters, click the  button.

**Filters are applied** by double-clicking a listbox or clicking the  [binoculars] button.

To **select multiple items in a listbox**, hold down the [CTRL] or [SHIFT] keys on the keyboard while clicking desired filter criteria.

For example, one could quickly find all of the models in *HVAC Lookup* that were made by either Carrier or Addison from 1970-1979 with a capacity between 9001 and 15000 BTUs:

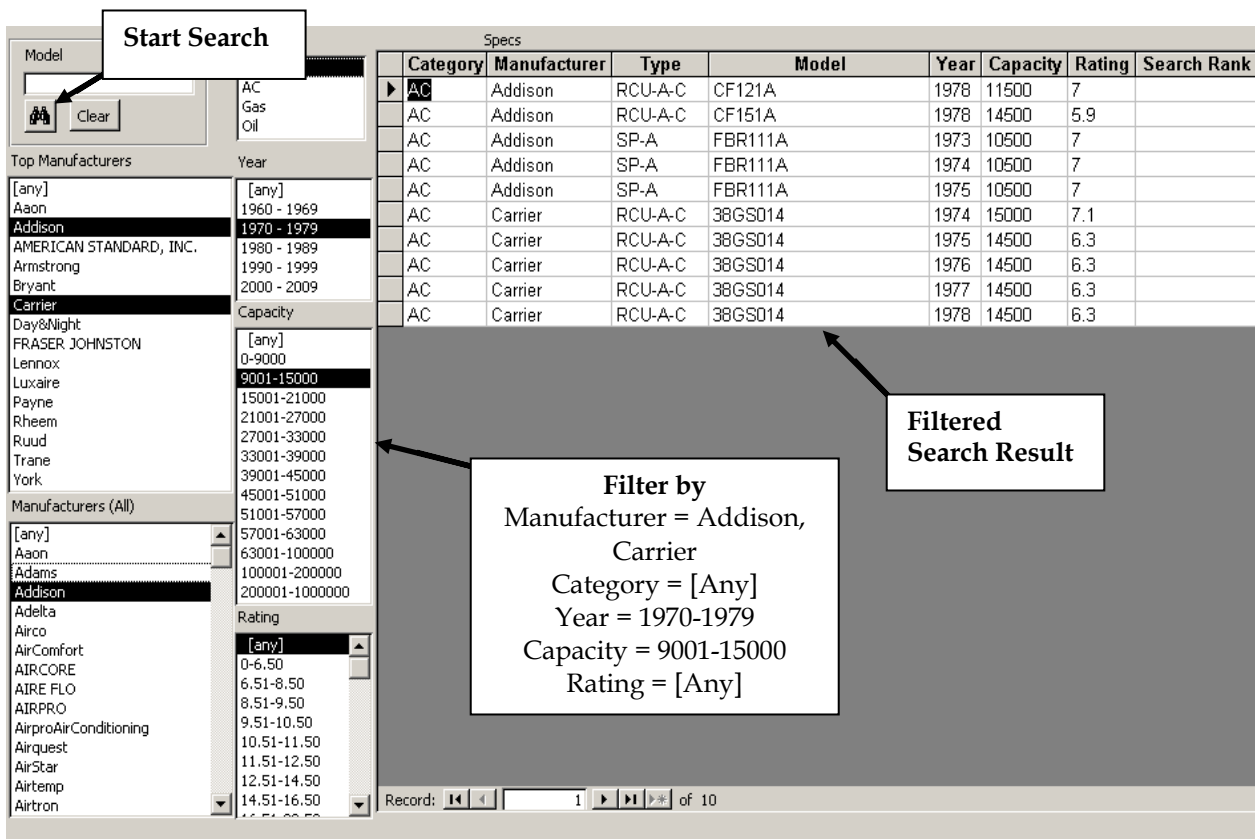

The screenshot shows the HVAC Lookup application interface. On the left, there are several filter listboxes: 'Model', 'Top Manufacturers', 'Year', 'Capacity', and 'Manufacturers (All)'. A 'Start Search' callout points to the search button. The 'Year' listbox has '1970 - 1979' selected. The 'Capacity' listbox has '9001-15000' selected. The 'Manufacturers (All)' listbox has 'Addison' and 'Carrier' selected. A 'Filtered Search Result' callout points to the table. A text box in the center lists the filter criteria: 'Filter by Manufacturer = Addison, Carrier; Category = [Any]; Year = 1970-1979; Capacity = 9001-15000; Rating = [Any]'. The table on the right shows the results of this search, with columns for Category, Manufacturer, Type, Model, Year, Capacity, Rating, and Search Rank. The first row is highlighted.

Category	Manufacturer	Type	Model	Year	Capacity	Rating	Search Rank
AC	Addison	RCU-A-C	CF121A	1978	11500	7	
AC	Addison	RCU-A-C	CF151A	1978	14500	5.9	
AC	Addison	SP-A	FBR111A	1973	10500	7	
AC	Addison	SP-A	FBR111A	1974	10500	7	
AC	Addison	SP-A	FBR111A	1975	10500	7	
AC	Carrier	RCU-A-C	3BGS014	1974	15000	7.1	
AC	Carrier	RCU-A-C	3BGS014	1975	14500	6.3	
AC	Carrier	RCU-A-C	3BGS014	1976	14500	6.3	
AC	Carrier	RCU-A-C	3BGS014	1977	14500	6.3	
AC	Carrier	RCU-A-C	3BGS014	1978	14500	6.3	

### Pattern Matching and Ranking

In the real world, model numbers are often obscured, written down incorrectly or simply unknown. *HVAC Lookup* provides a fast and powerful pattern matching algorithm for ranking search results. This greatly facilitates finding the correct model number and model information.

For example, suppose a field representative called in model “38ARS01111c”. In this example, “38ARS01111c” is not in *HVAC Lookup*. To find the nearest matches, enter the model number and click the  [binoculars] button. This is shown below:

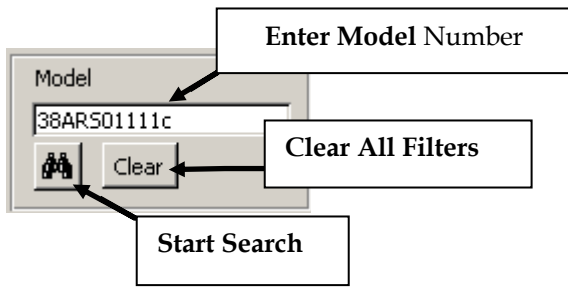

A pattern matching search of “38ARS01111c” yields this results [top four results shown]:

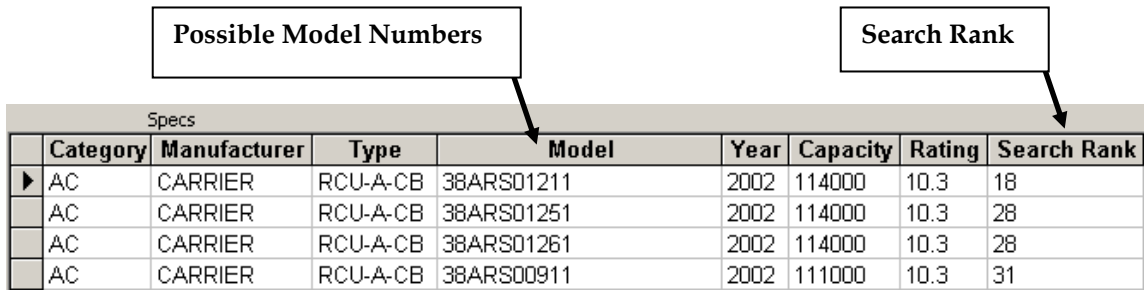

Specs								
	Category	Manufacturer	Type	Model	Year	Capacity	Rating	Search Rank
▶	AC	CARRIER	RCU-A-CB	38ARS01211	2002	114000	10.3	18
	AC	CARRIER	RCU-A-CB	38ARS01251	2002	114000	10.3	28
	AC	CARRIER	RCU-A-CB	38ARS01261	2002	114000	10.3	28
	AC	CARRIER	RCU-A-CB	38ARS00911	2002	111000	10.3	31

In this example, “38ARS01211” appears to be closest to “38ARS01111c”. The match is not exact and requires human judgement. By ranking the results, *HVAC Lookup* helps reduce the amount of tedious labor required to gather all of the likely candidates together.

*HVAC Lookup* also very effectively deals with slight typos or slightly illegible model numbers. For example, if a user incorrectly searches on the model “38ARS01211” instead of “38ARS01211” (in other words, the last character, the number “1,” has been misread as the letter “l”), *HVAC Lookup* will find the likely match:



**Pattern Matching Example**

User entered: "38ARS01211"  
*HVAC Lookup* contains: "38ARS01211"

Specs								
	Category	Manufacturer	Type	Model	Year	Capacity	Rating	Search Rank
▶	AC	CARRIER	RCU-A-CB	38ARS01211	2002	114000	10.3	7

**Combining Filters with Pattern Matching and Ranking**

*HVAC Lookup* allows both filters **and** pattern matching to operate at the same time. This can be useful to limit the scope of a pattern matching search. For instance, the manufacture may be known.

To combine filters and pattern matching, select all desired filter criteria, enter the model number and click the  [binoculars] button.

For example, the search below shows the results for a search on **only** Carrier gas models made before 1990 that are close to the model number "349FAD0240X":

Model

 Clear

Category

[any]

AC

Gas

Oil

Specs

	Category	Manufacturer	Type	Model	Year	Capacity	Rating	Search Rank
▶	Gas	Carrier		349FAD024050	1986	50000	67.5	19
	Gas	Carrier		349FAW024050	1986	50000	72.5	29
	Gas	Carrier		349FAD030075	1986	75000	67.5	36
	Gas	Carrier		349FAD036050	1986	50000	67.5	36
	Gas	Carrier		349FAD036075	1986	75000	67.5	36
	Gas	Carrier		349FAD036100	1986	100000	67.5	36
	Gas	Carrier		349FAD054140	1986	140000	66	36
	Gas	Carrier		349FAD060140	1986	140000	67.5	36
	Gas	Carrier		349FAD066140	1986	140000	67.5	36
	Gas	Carrier		349FAD000050	1986	50000	67.5	39
	Gas	Carrier		349FAD000075	1986	75000	67.5	39
	Gas	Carrier		349FAD000100	1986	100000	67.5	39

Top Manufacturers

[any]

Aaon

Addison

AMERICAN STANDARD, INC.

Armstrong

Bryant

Carrier

Day&Night

FRASER JOHNSTON

Lennox

Year

[any]

1960 - 1969

1970 - 1979

1980 - 1989

1990 - 1999

2000 - 2009

Capacity

[any]

0-9000

### Sorting

*HVAC Lookup* takes advantage of Microsoft Access's built in sorting function. To sort a search result,

click the desired result column and then click the  or  button (located on the Records, Sort Menu or Microsoft Access toolbar).

In the example below, the search results are sorted by capacity:

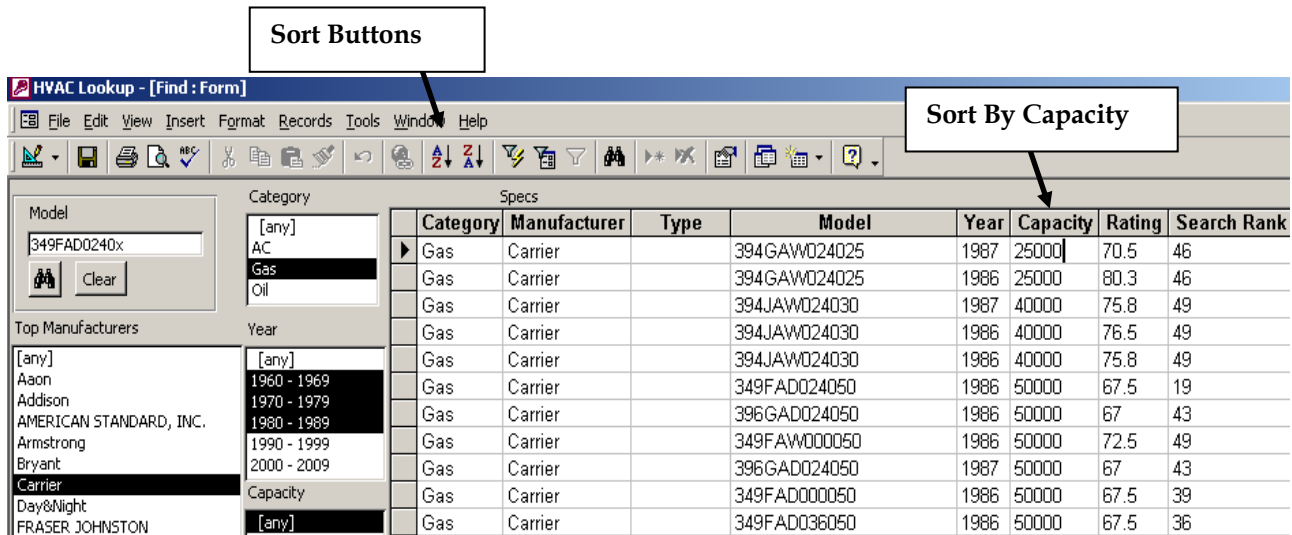

The screenshot shows the HVAC Lookup application interface. The main window is titled "HVAC Lookup - [Find : Form]". The menu bar includes File, Edit, View, Insert, Format, Records, Tools, Window, and Help. The toolbar contains various icons, including a "Sort" button with an "A-Z" icon. A callout box labeled "Sort Buttons" points to this icon. The main area is divided into several sections: "Model" (with a search box containing "349FAD0240x" and a "Clear" button), "Category" (with a dropdown menu showing "AC", "Gas", and "Oil"), "Top Manufacturers" (with a list of manufacturers including "Carrier"), "Year" (with a dropdown menu showing "1960 - 1969", "1970 - 1979", "1980 - 1989", "1990 - 1999", "2000 - 2009", and "Capacity"), and "Specs" (a table of search results). A callout box labeled "Sort By Capacity" points to the "Capacity" column header in the "Specs" table. The table is sorted by Capacity in descending order.

Category	Manufacturer	Type	Model	Year	Capacity	Rating	Search Rank
Gas	Carrier		394GAW024025	1987	25000	70.5	46
Gas	Carrier		394GAW024025	1986	25000	80.3	46
Gas	Carrier		394JAW024030	1987	40000	75.8	49
Gas	Carrier		394JAW024030	1986	40000	76.5	49
Gas	Carrier		394JAW024030	1986	40000	75.8	49
Gas	Carrier		349FAD024050	1986	50000	67.5	19
Gas	Carrier		396GAD024050	1986	50000	67	43
Gas	Carrier		349FAV000050	1986	50000	72.5	49
Gas	Carrier		396GAD024050	1987	50000	67	43
Gas	Carrier		349FAD000050	1986	50000	67.5	39
Gas	Carrier		349FAD036050	1986	50000	67.5	36

### Wildcards

*HVAC Lookup* uses Microsoft Access standard wildcards. The asterisk ("\*") is a wild card for multiple characters while the question mark ("?") is a wildcard for a single character. It is possible to use combinations of asterisks and question mark wildcards.

By default, *HVAC Lookup* appends an asterisk ("\*") to the end of a model number as it is being typed in so that the user can instantaneously see results.

For example, a filtered search on “34??AD\*0” yields:

**Wildcards Used**

**Models matching  
the wildcard search**

	Category	Specs						
Model		Category	Manufacturer	Type	Model	Year	Capacity	Rating
34??AD*0	[any]	Gas	Carrier		349FAD024050	1986	50000	67.5
	AC	Gas	Carrier		349FAD066140	1986	140000	67.5
	Gas	Gas	Carrier		349FAD060140	1986	140000	67.5
	Oil	Gas	Carrier		349FAD054140	1986	140000	66
		Gas	Carrier		349FAD036100	1986	100000	67.5
		Gas	Carrier		349FAD036075	1986	75000	67.5
		Gas	Carrier		349FAD036050	1986	50000	67.5
		Gas	Carrier		349FAD030075	1986	75000	67.5
		Gas	Carrier		349FAD048100	1986	100000	67.5
		Gas	Carrier		349FAD000100	1986	100000	67.5
		Gas	Carrier		349FAD000075	1986	75000	67.5
		Gas	Carrier		349FAD000050	1986	50000	67.5
		Gas	Carrier		349FAD060125	1987	125000	67.5
		Gas	Carrier		349FAD060125	1986	125000	67

Top Manufacturers	Year	Capacity
[any]	[any]	[any]
Aaon	1960 - 1969	
Addison	1970 - 1979	
AMERICAN STANDARD, INC.	1980 - 1989	
Armstrong	1990 - 1999	
Bryant	2000 - 2009	
Carrier		
Day&Night		
FRASER JOHNSTON		
Lennox	0-9000	
Luxaire	9001-15000	
Payne	15001-21000	
Rheem	21001-27000	